

Envirotainer[®]

The Active Cold Chain

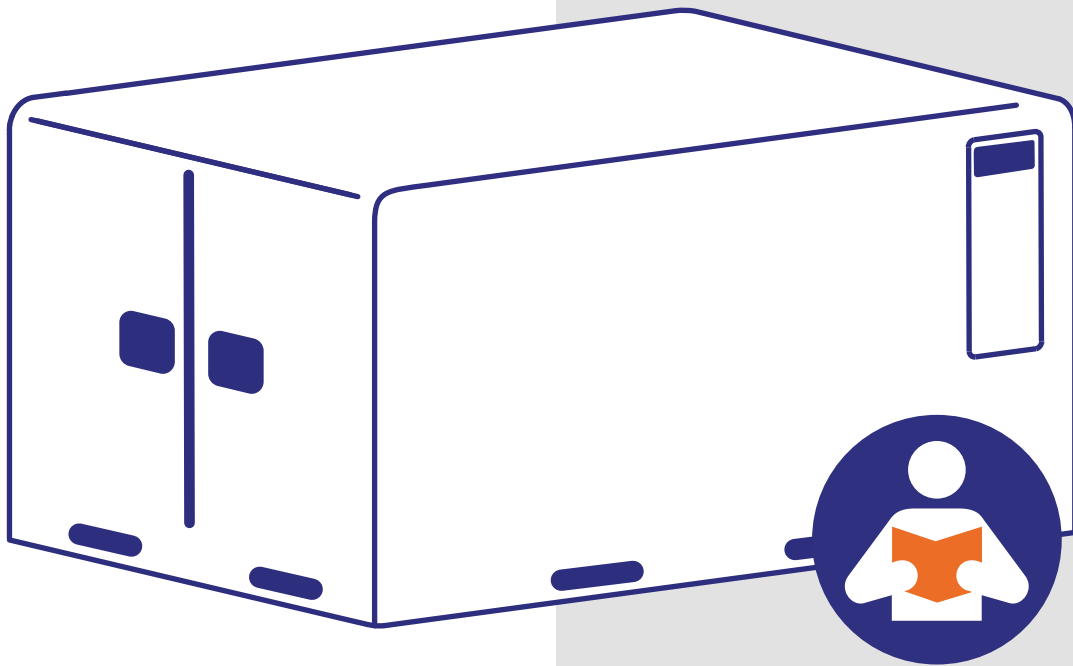

RAP e2 container Operations Manual

RAP container,
Model 140010R, P/N 140010R-(), P/N
140010R-A-()-(), P/N 140010R-B-()-()

Doc No. MO-RAP-3079
Version 24

www.envirotainer.com

Doc No:

MO-RAP-3079

Revision:

24

State

Released

Release date:

2024-02-08

Approved by

bernta

RECORD OF REVISION

VER. NO.	REVISION
24	REVISED: <ul style="list-style-type: none">• 2.1.2 Symbols on the container: Added the NED sticker.• 4.4.5.5 Additional charging adapters: Removed adapters P/N 807W and P/N 807Z from list of additional adapters.

TABLE OF CONTENTS

1. INTRODUCTION	1
1.1 Container type	1
1.2 Intended use	1
1.2.1 Operating environment	1
1.3 Manufacturer	2
1.4 Contact	2
1.5 How to use the manual	2
1.6 Declaration of conformity	3
2. SAFETY	4
2.1 Symbols	4
2.1.1 Symbols in the manual	4
2.1.2 Symbols on the container	5
2.2 Safety instructions	6
2.2.1 General	6
2.2.2 Charging	6
2.2.3 Lifting and moving the container	6
3. CONTAINER DESCRIPTION	7
3.1 Orientation conventions	7
3.2 Overview	8
3.3 Refrigeration system operation	9
3.4 Attachment points for security seals	10
3.5 Battery duration	11
3.6 Temperature control capacity	11
3.7 Loading capacity	11
3.8 Operating conditions	12
	→

4. USING THE CONTAINER	13
4.1 Preparing a shipment.....	14
4.2 Shipping	15
4.3 Finishing a shipment.....	16
4.4 Operating Instructions.....	17
4.4.1 Lifting and moving the container	17
4.4.2 Pre-conditioning cargo and container	20
4.4.3 Recording temperatures	21
4.4.4 Loading cargo.....	22
4.4.5 Charging the container	25
4.4.6 Handling the container during shipment	34
4.4.7 Storing the container	35
4.4.8 Operating the control unit	36
4.4.9 Connectivity switch	43
5. TROUBLESHOOTING.....	45
5.1 Infos.....	45
5.2 Alerts.....	46
5.3 Alarms.....	49
5.4 Hardware.....	49
6. TECHNICAL SPECIFICATION.....	51
6.1 Definition of dimensions	52

1. INTRODUCTION

This manual provides information for personnel involved in the operation of Envirotainer container series RAP e2 and is published by Envirotainer AB without warranty.

1.1 CONTAINER TYPE

The container is an active Unit Load Device (ULD) according to ETSO-C90c, including non-ETSO functions, primary to keep cargo in a temperature-controlled environment.

The container is a 2A2C designed according to NAS 3610 and LD-9.

1.2 INTENDED USE

The RAP e2 is a temperature controlled air cargo container designed to transport temperature-controlled products with temperature ranges between 0 and 25 degrees Celsius (32 °F to 77 °F). It is intended for use in aircrafts, trucks and trains. The container may also be transported by ship when empty or loaded with non temperature sensitive cargo.

The container can be used indoors or outdoors. Operating conditions when transporting temperature sensitive cargo is stated in **3.8 Operating conditions**.

The container may only be handled and operated by trained personnel, and in accordance with the instructions given in this manual. Operational limitations regarding maximum gross weight, ambient temperatures and power requirements stated in **6. Technical Specification** must not be exceeded.

When loaded on an aircraft, the container must run on battery power or be shut off. It must never be connected to a power supply inside an aircraft.

If applicable, the use of the container must follow the "IATA Dangerous Goods Regulations".

Connectivity:

The container **P/N 140010R-B-()-()** is provided with connectivity equipment for wireless data transmission. This equipment has built in flight detection in accordance with AC 91.21-1D, sections 10.2 and 10.3. It uses two independent means to control the RF transmitters and automatically turns off the RF transmitters when the container comes to close to an aircraft.

A manual connectivity switch is also available, to override the automatic flight detection and enable transport on an aircraft for which the operator has not approved the use of equipment based on automatic flight detection in accordance with AC 91.21-1D, sections 10.2 and 10.3

1.2.1 OPERATING ENVIRONMENT

The container is designed to meet the following environmental conditions:

Maximum altitude (unpressurized)	AC power: 3000 m (9842 ft)
	Battery power: 4600 m (15 092 ft)
Maximum supply voltage fluctuations	Up to ±10 % of the nominal voltage
Overvoltage category	Category II
Applicable pollution degree	Pollution degree 3

→

Container enclosure ingress protection code	IP15B
	1: Protection from solid objects, such as hands, greater than Ø 50 mm (1.97") from touch
	5: Protection from low pressure water jets from any direction
	B: Protection against access with bendable probe, such as a finger, greater than Ø 12 mm (0.47") and length less than 80 mm (3.15") from touch

1.3 MANUFACTURER

The container is manufactured and provided by:

Envirotainer Engineering AB

Staffans väg 2A

SE-192 78 Sollentuna

SWEDEN

1.4 CONTACT

For contact information to our operations centers, refer to www.envirotainer.com.

For questions regarding the container or for reporting misleading, incorrect or insufficient data in the manual, send an e-mail to support@envirotainer.com.

1.5 HOW TO USE THE MANUAL

Before handling and operating the container, carefully read and understand chapter **2. Safety**, and get acquainted with the container and the operating conditions in chapter **3. Container description**.

When handling the container before, during and after shipment*, follow the checklists in chapters **4.1 Preparing a shipment**, **4.2 Shipping** and **4.3 Finishing a shipment** to make sure that all necessary measures for a successful shipment are taken. The checklists contain references to relevant operating instructions.

If any problem should arise, refer to chapter **5. Troubleshooting** for possible solutions.

* Definitions of the three shipment stages are found in **4. Using the container**.

1.6 DECLARATION OF CONFORMITY



DECLARATION OF CONFORMITY
according to EN ISO/IEC 17050-1:2010



Manufacturer's Name: Envirotainer Engineering AB
Manufacturer's Address: Staffans väg 2A, SE-192 78 Sollentuna, Sweden
Manufacturing Site: Tallbacksgatan 12, SE-195 72 Rosersberg, Sweden

Declares under sole responsibility that the product as originally delivered

Product Name: RAPe2
Model Number: 140010R
Part Number: 140010R-B-()-()

complies with the essential requirements of the following applicable European Directive(s), and carries the CE marking accordingly:

Radio Equipment Directive 2014/53/EU (RED)

through the technical standards/specifications specified below:

EMC/Radio
 EN 61000-6-1:2016 (Immunity, light industry environment)
 EN 61000-6-8:2020 (Emission, light industry environment, professional use)
 ETSI EG 203 366 V.1.1.1 (2016-06) RED guideline for combined radio products

Safety
 ISO 12100:2010 (risk assessment)
 EN 61010-1:2012+A1:2019 (in part)
 EN 60204-1:2006 (in part, AIR200)
 EN 378-1, -2 (in part, AIR200)
 RTCA/DO-293a (in part, Batteries)
 EN 62368-1:2014+A11:2017 (in part, Power Supply)
 IEC 60529 Ed. 2.2:2013 (Ingress Protection, class IP15B)

Additional information:
 This product is an Air Cargo Unit Load Device (ULD) container 2L5C with temperature control system AIR200 (heating and cooling) and a connectivity system (Cargo Tracking Device), which contains a separately CE-marked and FCC/IC listed transmitting device, and carries that FCC and IC identifications numbers on the manufacturer's label.

Local contact for regulatory topics only:
 EU: Envirotainer Engineering AB, Staffans väg 2A, SE-192 78 Sollentuna, Sweden
 U.S.: Envirotainer Inc. 222 West Las Colinas Blvd Suite 1605 North Tower Irving TX 75039 USA
www.envirotainer.com



 (Bernt Anderberg, CTO)

Rosersberg Sweden, 10 Feb 2023
 (Place and date of issue)

Document number: RE-00059	Revision: 0	Status: Released
Author: Bure Heed	Date: 2023-02-22	Approver: bernta

Page 1 of 1

G00006719

Fig. 1 Declaration of conformity

2. SAFETY

This chapter contains safety instructions and explanations of safety related symbols in the manual and on the container. For safe handling of the container, make sure to read the instructions before use, and pay attention to the warning stickers attached to the container.

2.1 SYMBOLS

2.1.1 SYMBOLS IN THE MANUAL

The following symbols are used in the manual:

**WARNING!**

Indicates a possible danger that **can** lead to death or serious injury if necessary measures are not taken.

**CAUTION!**

Indicates a possible hazard that **can** lead to injury or material / equipment damage if necessary measures are not taken.

**NOTE!**

Practical information or tips on how to perform a procedure.

2.1.2 SYMBOLS ON THE CONTAINER

This section contains explanations of safety related symbols and stickers on the container, and information about where they are found.

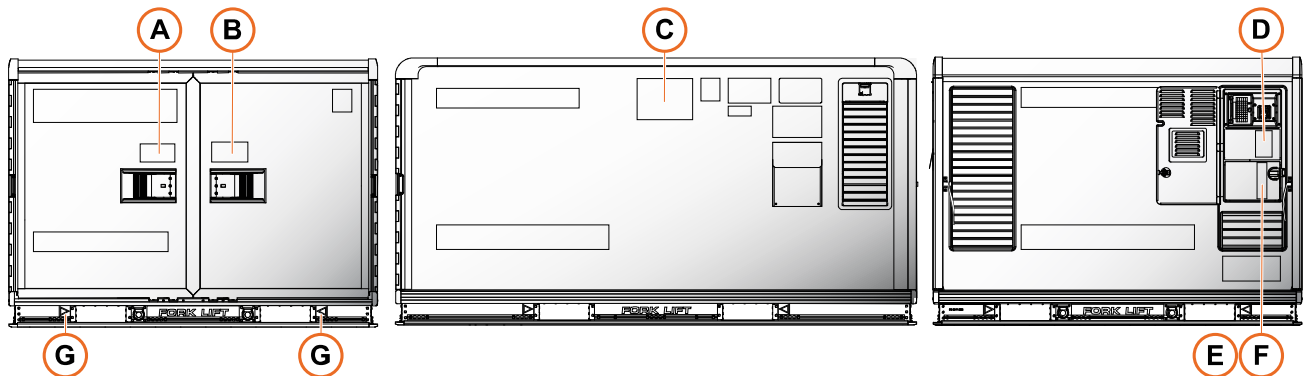
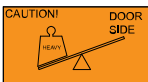





Fig. 2 Placement of symbols and stickers on the container

Table 1 Symbols/stickers on the container

Pos	Symbol/sticker	Explanation
A		Risk of crush injury. The center of gravity is offset due to the weight of the refrigeration system at the rear of the container. It is not recommended to lift the container from the front (the door side).
B	Handling instruction	The sticker contains important handling instructions. Make sure to follow the instructions during container handling.
C	ODLN sticker	The container is labeled with an Operational Damage Limits Notice (ODLN) sticker, to meet the IATA labelling requirements for aircraft containers. The ODLN describes the acceptable damage limits from an airworthiness perspective and can be used for safe loading on to the aircraft. Before every lease, the containers are inspected against even stricter criteria than those stated on the ODLN. Therefore, the container will never exhibit the level of damage as described on the ODLN when released from an Envirotainer station.
D	Instruction for post charging inspection	The sticker contains instructions for an inspection to be performed after charging the container. Failure to follow the instruction may put the cargo at risk, as the container may not be able to keep the set temperature.
E		Risk of fire, and violation of the aircraft security. Do not charge the container inside an aircraft.
F		Risk of container damage. Always pull out all of the charging cable when charging, approximately 10 meters (32 ft.). Charging with part of the cable left inside the cable winder can cause damage to the cable winder.
G		When lifting the container with forklift, insert the forklift forks into the slots as indicated by the arrows (present on all sides of the container).
		The NED sticker serves as a temporary repair method, sealing minor defects in the laminate, preventing moisture and dirt from entering. This reduces unnecessary transports and also contributes to environmental sustainability. The defect beneath the sticker has no effect on the container's airworthiness or functionality.

2.2 SAFETY INSTRUCTIONS

2.2.1 GENERAL

 **CAUTION!**

Observe normal precautions when handling locks, doors and lids.

2.2.2 CHARGING

 **WARNING!**

Risk of fire, and violation of the aircraft safety. Do not charge the container inside an aircraft or other means of transportation.

 **WARNING!**

Risk of electric shock. Do not charge the container outdoors or in damp and/or humid environments.

 **WARNING!**

Make sure that the power outlet in the building is provided with protective earth before connecting the charging cable.

 **WARNING!**

Risk of electric shock. Visually inspect the charging cable, and any adapters used, for any abnormalities before connecting it to a power supply. Connectors shall be inspected for residual water or other contamination. If the cable is damaged, bypass the cable winder. Refer to **4.4.5.6 Bypass the cable winder for charging**.

 **CAUTION!**

Tripping hazard. Avoid loops, walkways and forklift routes when routing the charging cable.

2.2.3 LIFTING AND MOVING THE CONTAINER

 **WARNING!**

Risk of electric shock. Do not move the container when the charging cable is connected to a power supply.

 **CAUTION!**

Risk of crush injury. The container's center of gravity is displaced due to the weight of the refrigeration system at the rear of the container. Follow the lifting instructions. Refer to: **4.4.1 Lifting and moving the container**

3. CONTAINER DESCRIPTION

3.1 ORIENTATION CONVENTIONS

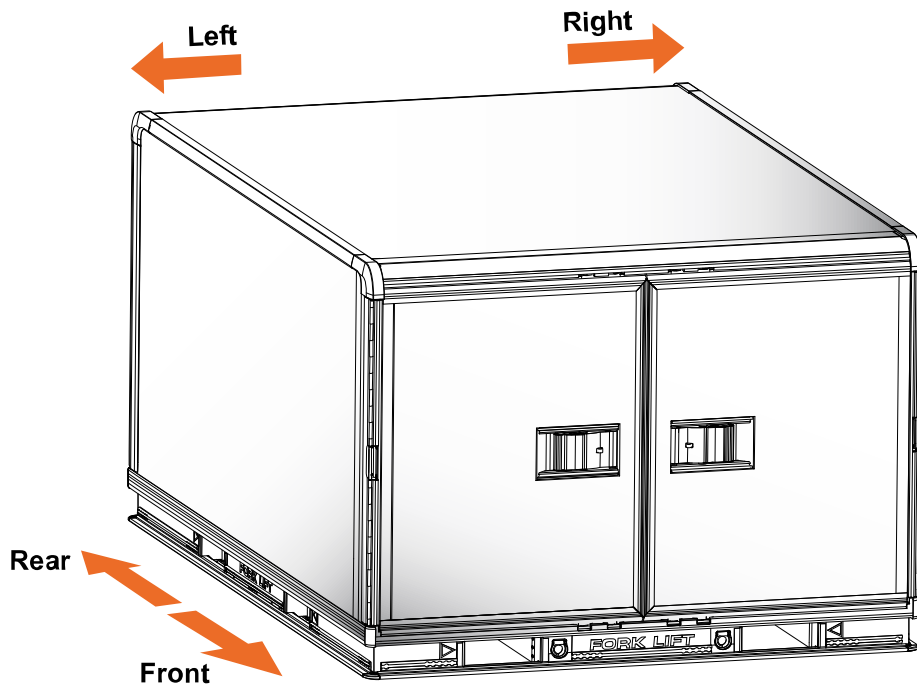

Fig. 3 Schematic view of the container with orientation conventions

3.2 OVERVIEW

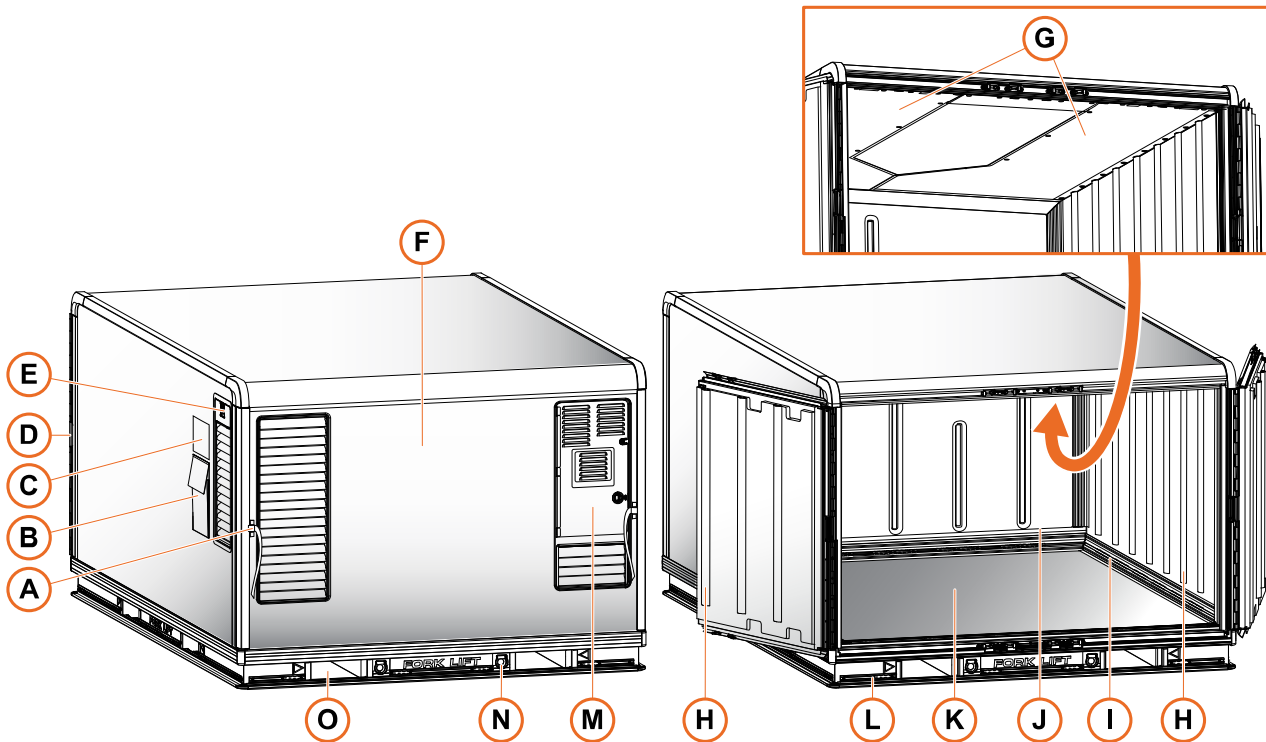

Fig. 4 Overview of the container

Table 2 Container features

Pos	Name	Description
A	Strap handle	For handling the container on roller beds.
B	Placard holder	For shipping documents, checklists etc.
C	Label area	For attachment of labels.
D	Handle	For handling the container on roller beds.
E	Control unit	For turning the container on/off, changing settings and viewing information. Can be sealed with a security seal.
F	Refrigeration system	(In the machine room behind the service hatch.) Regulates the temperature of the air to keep the cargo space at the required temperature.
G	Air guide	Distributes temperature-controlled air into the cargo space.
H	Spacer	Distributes temperature-controlled air into the cargo space, and secures a distance between the cargo and the container walls for air circulation purposes.
I	Internal tie-down bracket	Attachment point for cargo straps, to secure the cargo.
J	Return air outlet	For return air from the cargo space.
K	Cargo space	Temperature controlled area for cargo.
L	External tie-down bracket	Attachment point for securing the container during transport.



Table 2 Container features (cont'd.)

Pos	Name	Description
M	Charging unit	For charging the internal batteries of the container. Contains charging cable, adapters, and holder for ambient temp data logger.
N	Eyelets	Attachment point for pulling devices.
O	Forklift pocket	Insertion point for forklift forks.

3.3 REFRIGERATION SYSTEM OPERATION

The refrigeration system is powered by internal, rechargeable batteries, and controlled by the control unit. A temperature sensor placed behind the rear wall of the cargo space, in the machine room, sends signals to the control unit, which turns heaters and cooling circuits in the mechanical refrigeration unit on and off as required. Temperature-controlled air is constantly circulated from the mechanical refrigeration unit through the air guides in the ceiling and into the cargo space (**Fig. 5**). The air travels along the inner floor and re-enters the refrigeration system through the return air duct in the partition wall at the rear of the cargo space.

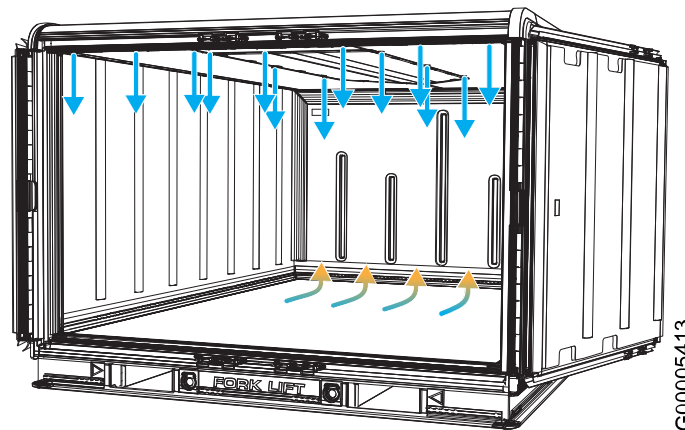

Fig. 5 Schematic view of the internal airflow in the container

The container is fitted with multiple independent systems for redundancy and reliability purposes:

- four air circulation fans
- three batteries
- two heaters
- three separate cooling circuits

This means that even if one component (fan, battery, heater, or cooling circuit) malfunctions during a shipment, the shipment can most likely be carried through without temperature deviations, as long as the container is not exposed to extreme ambient conditions.

3.4 ATTACHMENT POINTS FOR SECURITY SEALS

The container is equipped with three attachment points for security seals:

- One per door lock (A) (two in total)
- One on the control unit lid (B)

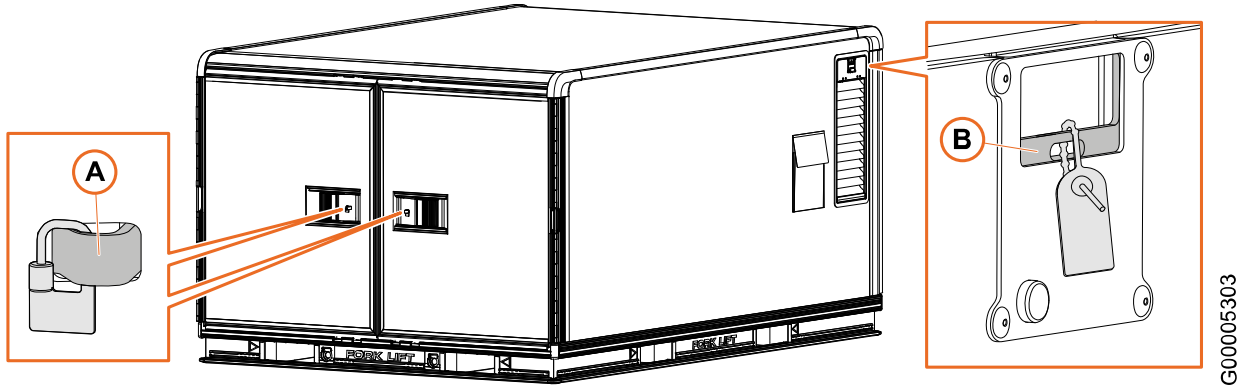

Fig. 6 Attachment points for security seals

Envirotainer recommends sealing both the doors and the control unit lid before shipment, as this can prevent (or help to detect):

- theft or contamination of cargo
- accidental or deliberate tampering with the control unit settings

NOTE!

It is possible to view information on a sealed control unit, but the settings cannot be changed.

Refer to **Table 3** for recommended security seal properties per attachment point. Note however that the effectiveness of a security seal is dependent on the way that it is used, and that procedures for record keeping, installation, inspection, removal and disposal are required.

Table 3 Recommended security seal properties

Placement	Properties
Doors	Maximum Ø 4,5 mm (0.18")
Control unit	Ø 2-4 mm (0.08-0.16")

3.5 BATTERY DURATION

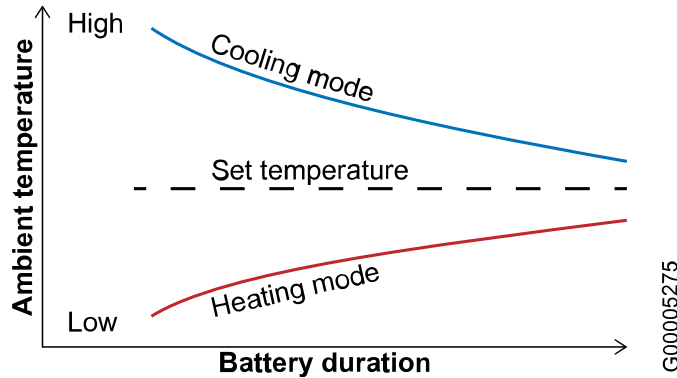

Fig. 7 Battery duration relative to ambient temperature and set temperature

The container battery duration (the operating time without recharging) depends on the following:

- the container set temperature
- the ambient temperature

The battery duration increases as the temperature difference between the ambient temperature and the container set temperature decreases (**Fig. 7**). This means that the maximum operating time is achieved when the ambient temperature is equal to the set temperature.

The operating conditions are further described in **3.8 Operating conditions**.

3.6 TEMPERATURE CONTROL CAPACITY

The container can be set at any temperature between 0 and +25 °C (+32 and +77 °F) with increments of 0.5 °C (1.8 °F).

3.7 LOADING CAPACITY

The RAP e2 is an LD-9 air cargo container designed to hold the following number of standard pallets:

Table 4 Loading capacity

Pallet	Max pcs	Pallet size
EURO	5	1200 x 800 mm (47.3 x 31.5")
US	4	1220 x 1016 mm (48 x 40")

3.8 OPERATING CONDITIONS

To ensure a successful shipment, the following conditions must apply:

- The cargo and the container must be pre-conditioned to the required set temperature.
Refer to **4.4.2 Pre-conditioning cargo and container**.
- The correct set temperature must be set on the control unit.
Refer to **4.4.8.4 Set the temperature**.
- The container must have sufficient battery power to operate throughout the shipment.
Refer to **4.4.8.6 Check the battery level**.
- The cargo must be loaded onto pallets and safely strapped in the container.
Refer to **4.4.4 Loading cargo**.
- The container must not be exposed to ambient temperatures outside the operation range, and preferably not to temperatures outside the recommended range.
Refer to **6. Technical Specification**. Refer to **Table 5** for a description of the container performance at set temperature +5 °C (41 °F) relative to different ambient temperature ranges.

Table 5 Container performance at set temp +5 °C (41 °F)

Ambient temperature	Within operation range*	Container performance at set temp 5 °C (41 °F)
Very high: +40 to +50 °C (+104 to +122 °F)	No	The container remains operational, but may not be able to maintain the set temperature. Very high ambient temperatures are not safe for the cargo.
High: +30 to +40 °C (+86 to +104 °F)	Yes	The container can maintain the set temperature, but the battery consumption will increase. As a result, the container operating time will decrease.
Normal (recommended): -10 to +30 °C (+14 to +86 °F)	Yes	Normal container performance. For minimum operating time, refer to 6. Technical Specification . The maximum operating time is achieved when the ambient temperature is equal to the set temperature, refer to 3.5 Battery duration .
Low: -10 to -25 °C (+14 to -13 °F)	Yes	The container can maintain the set temperature, but the battery consumption will increase. As a result, the container operating time will decrease.
Very low: -25 to -30 °C (-13 to -22 °F)	No	The container remains operational, but may not be able to maintain the set temperature. Very low ambient temperatures are not safe for the cargo.

*Refer to **6. Technical Specification**.

4. USING THE CONTAINER

A shipment (B) is defined as all land and air transportation that is required to transfer a loaded container from the shipper site (A) to the consignee site (C).

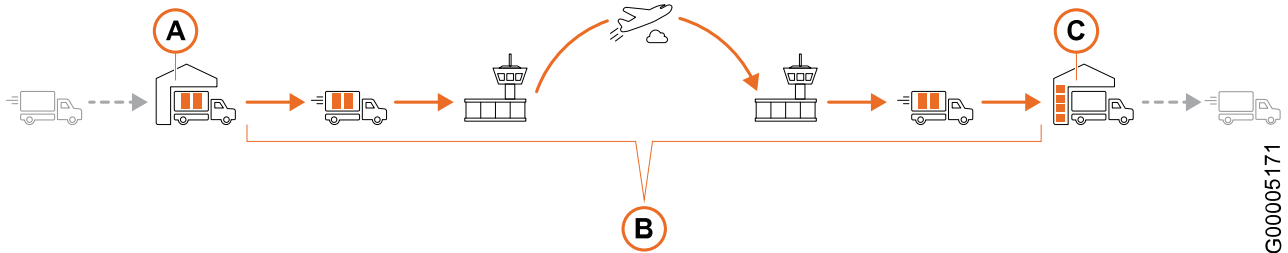

Fig. 8 The shipment

G00005171

Chapters **4.1-4.3** contain three separate checklists, listing the actions to be performed when preparing a shipment, shipping the container, and finishing the shipment. Follow the applicable checklist, as defined below, to make sure that all necessary measures for a successful shipment are taken. The checklists contain references to relevant operating instructions.

- *Preparing a shipment:* Container handling at the shipper site, from receiving the empty container to handover of the loaded container.
- *Shipping:* Container handling during land transportation to and from the airport, and at the airport. To be performed by forwarders and airport personnel.
- *Finishing a shipment:* Container handling at the consignee site, from receiving the loaded container to handover of the empty container.

The checklists may be printed out to make sure that they are completed.

4.1 PREPARING A SHIPMENT

Before shipment, the following must be performed:

- Pre-condition the cargo.
Refer to **4.4.2.1 Pre-condition the cargo.**
- Pre-condition the container.
Refer to **4.4.2.2 Pre-condition the container.**
- Load and strap the cargo.
Refer to **4.4.4 Loading cargo.**
- Make sure that all doors and covers are closed, latched and, if applicable, sealed.
Refer to **3.4 Attachment points for security seals.**
- Make sure that the batteries are properly charged. If not, charge the batteries.
Refer to **4.4.5 Charging the container.**
- Make sure that the correct set temp has been set, and that the container is within the required temperature range (check on the control unit display).
- Make sure that the yellow alert indicator and red alarm indicator on the control unit are not flashing*.
If they are, refer to **5. Troubleshooting.**
- Make sure that the container is not wrapped or covered.
Refer to **4.4.6.1 Shipping precautions.**
- Make sure that the container is handled and stored in an ambient temperature within the operation range.
Refer to **6. Technical Specification.**

* The yellow alert “**Inside temp out of spec;Check container**” (or “**Inside temp out of spec**” depending on software version) may appear due to the doors being open during loading. If so, make sure that the ambient temperature is within the specified limits, that the container temperature recovers and that the alert disappears within approximately 30 minutes after the doors have been closed. Otherwise, refer to **5. Troubleshooting.**

For instructions on lifting and moving the container, refer to **4.4.1 Lifting and moving the container.**

4.2 SHIPPING

During shipment, the following must be performed:

- Make sure that all doors and covers are closed, latched and, if applicable, sealed.
- Make sure that the container is not wrapped or covered.
Refer to **4.4.6.1 Shipping precautions**.
- Make sure that the red and yellow alert indicators on the control unit are not flashing.
If they are, refer to **5. Troubleshooting**.
- Make sure that the container is handled and stored in an ambient temperature within the operation range.
Refer to **6. Technical Specification**.
- Limit the time on the tarmac during aircraft loading (to avoid temperature extremes and weather conditions).
- Consider charging the container whenever it is in a warehouse.
Refer to **4.4.5 Charging the container**.

For instructions on lifting and moving the container or moving it using roller beds, refer to **4.4.1 Lifting and moving the container**.

For instructions on strapping the container, refer to **4.4.6.2 Strap the container**.

4.3 FINISHING A SHIPMENT

After shipment, the following must be performed:

- Unload the cargo.
- Close all doors and covers.
- Switch the container off.

Refer to **4.4.8.2 Switch the container on/off**.

For instructions on lifting and moving the container, refer to **4.4.1 Lifting and moving the container**.

For instructions on storage, including long-time storage (more than seven days), refer to

4.4.7 Storing the container.

4.4 OPERATING INSTRUCTIONS

4.4.1 LIFTING AND MOVING THE CONTAINER

⚠ WARNING!

Risk of electric shock. Do not move the container when the charging cable is connected to a power supply.

⚠ CAUTION!

Do not place the container on any electrical cables, such as the charging cables of other containers.

⚠ CAUTION!

Do not pull the container by the strap handles when the container is not placed on roller beds, as the strap handles may come loose.

Envirotainer recommends lifting the container using forklift rather than electric pallet jack.

4.4.1.1 LIFT WITH FORKLIFT

⚠ CAUTION!

Risk of crush injury. It is not recommended to lift the container from the rear, as the weight of the refrigeration system at the rear of the container may cause tilting.

⚠ CAUTION!

Risk of container damage. Do not drag the container against the ground.

The container can be lifted using a forklift when empty or loaded. The distance between the forklift pockets is 813 mm (32") (**Fig. 9**)

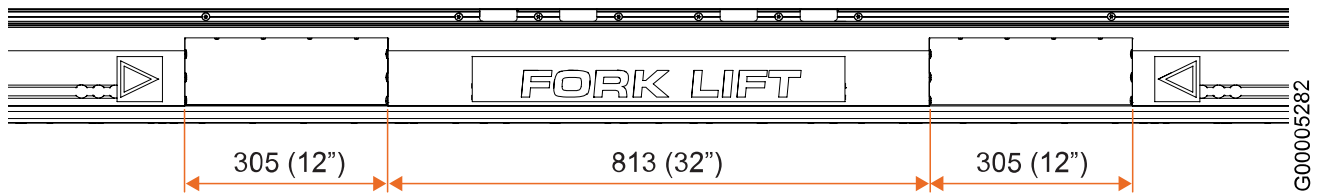

Fig. 9 Forklift pocket distance and dimensions

The minimum fork length required differs depending on if the container is lifted from the sides or from the front or rear, and if the container is empty or loaded. Refer to **Table 6**. For definitions of left, right, front and rear, refer to **3.1 Orientation conventions**.

Table 6 Fork length recommendations

Lifting from	Minimum fork length	
	Empty container	Loaded container
Left or right side	1,2 m (47.5")	1,6 m (63")
Front (not recommended) or rear	1,6 m (63")	2,2 m (87")

4.4.1.2 LIFT WITH ELECTRIC PALLET JACK

⚠ CAUTION!

Risk of crush injury. Always lift the container from the rear, as the weight of the refrigeration system at the rear may otherwise cause tilting. Do not lift the container higher than necessary.

⚠ CAUTION!

Risk of crush injury. Make sure that the pallet jack is wide enough to keep the container stable.

Use an electric pallet jack or electric walkie rider with the following properties:

- **Minimum rated lifting capacity:** Equal to the container total gross weight.
- **Minimum fork length:** 2,2 m (87").

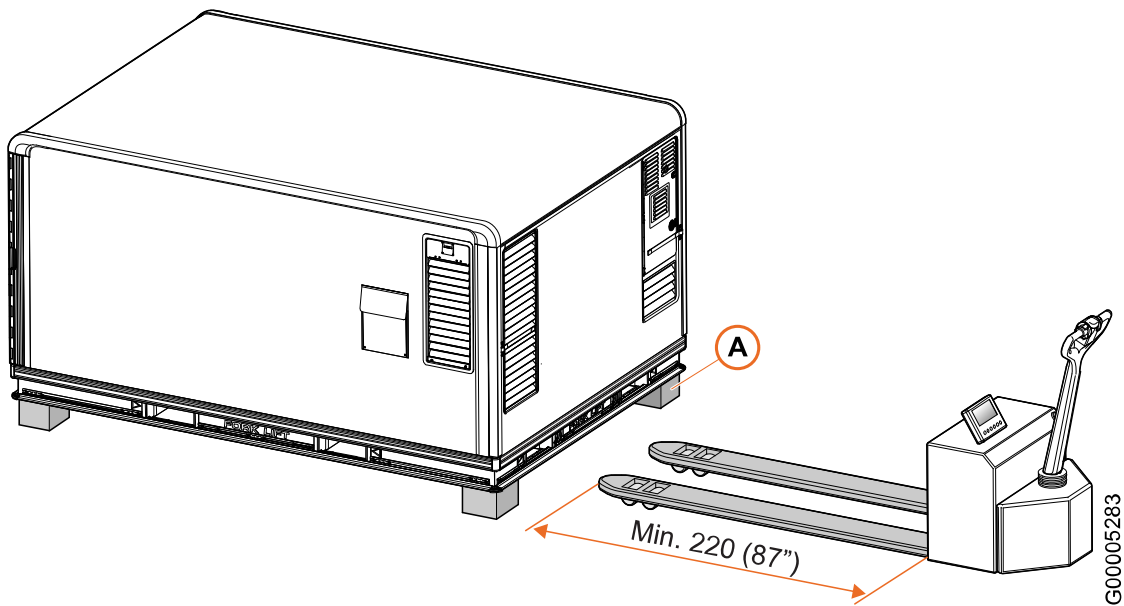

Fig. 10

1. Lift the container from the rear using the electric pallet jack.
2. Move the container to the desired location.
3. Place the container on supports (A) before removing the electric pallet jack.

4.4.1.3 MOVE USING A ROLLER BED SYSTEM

⚠ CAUTION!

Risk of crush injury. Do not stand in front of a moving container due to the weight of the container .

1. Use the front handles (A) or rear straps (B) on the container corners to handle the container on roller beds.

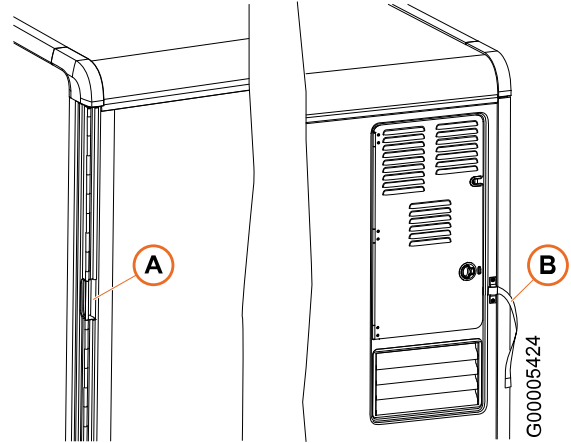

Fig. 11

4.4.2 PRE-CONDITIONING CARGO AND CONTAINER

The container is designed to maintain the temperature of the cargo. Before loading, the cargo and container must be pre-conditioned to the container set temperature.

CAUTION!

If pre-conditioning of cargo and container is not carried out correctly, the required cargo temperature may not be reached, and there is a large risk of temperature deviations during the shipment.

4.4.2.1 PRE-CONDITION THE CARGO

1. Pre-condition the cargo including all packing materials to the required transport temperature (the container set temperature) before loading.

4.4.2.2 PRE-CONDITION THE CONTAINER

There are two recommended ways to pre-condition the container:

4.4.2.2.1 Pre-condition with the container operating in non-temperature controlled area

Typically, pre-conditioning with the container operating can take up to 90 minutes, but time may vary depending on the ambient conditions and the desired set temperature. It is recommended that the pre-conditioning is performed with the container connected to a power supply, so that no battery power is consumed. Pre-conditioning during charging does not affect the charging time.

1. Perform a functional test of the container. Refer to **4.4.8.9 Perform a functional test**.
2. Make sure that the doors to the cargo space are closed.
3. Set the required temperature. Refer to **4.4.8.4 Set the temperature**.
4. Wait until the container has reached the required set temperature* before loading cargo.

The display switches between showing **CONTAINER INFO** and **Info, Preconditioning** until the temperature in the cargo space is within the temperature tolerance.

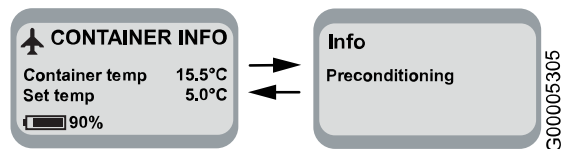

Fig. 12

* For temperature tolerances in the cargo space, refer to **6. Technical Specification**.

4.4.2.2.2 Pre-condition in a temperature-controlled room

1. Perform a functional test of the container. Refer to **4.4.8.9 Perform a functional test**.
2. Switch off the container. Refer to **4.4.8.2 Switch the container on/off**.
3. Place the container in a temperature-controlled room that holds the required set temperature.
4. Open the doors to the cargo space.
5. Allow at least 90 minutes for container pre-conditioning before loading the cargo.
6. Switch on the container and set the required temperature. Refer to **4.4.8.4 Set the temperature**.

4.4.3 RECORDING TEMPERATURES

4.4.3.1 CARGO TEMPERATURE

1. If cargo temperature records must be kept, preferably place temperature data loggers inside or between the cargo boxes.

NOTE!

The temperature displayed on the control unit is the average air temperature in the container. The air temperature fluctuates more than the actual temperature of the cargo.

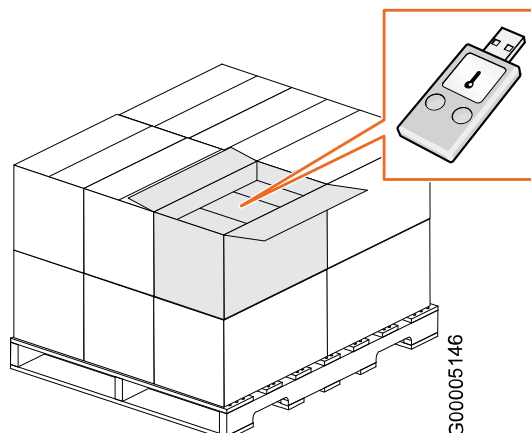

Fig. 13

4.4.3.2 AMBIENT TEMPERATURE

1. If ambient temperature records must be kept, place a temperature data logger in the ventilated box beside the charging unit.

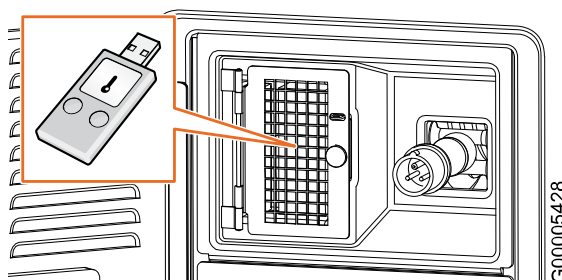



Fig. 14

4.4.4 LOADING CARGO

1. Make sure that both the cargo and the container have been pre-conditioned. Refer to **4.4.2 Pre-conditioning cargo and container.**

2.  **CAUTION!**
If the cargo is wrapped, make sure that the pallet base is not covered, as this would obstruct the airflow along the floor beneath the cargo.

Load the cargo on pallets to allow proper airflow underneath the cargo. Make sure to distribute the cargo weight evenly on the pallets.

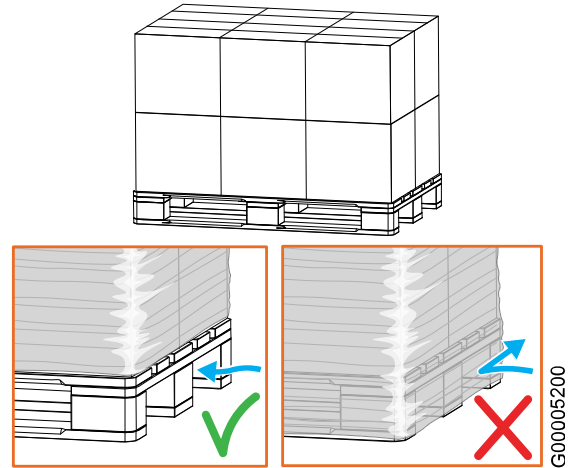

Fig. 15

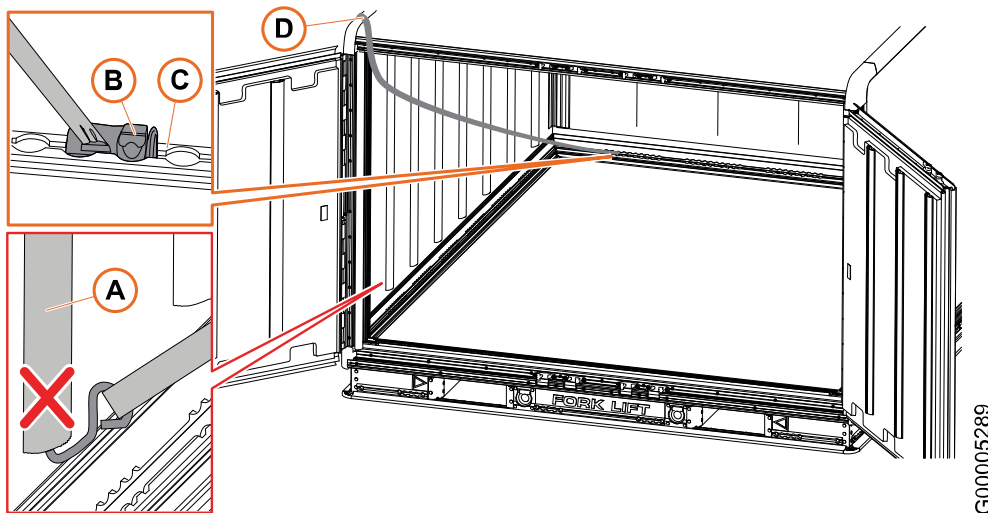



Fig. 16

3.  **CAUTION!**
Do not secure the straps to the spacers (A) on the container walls, as there is a risk of damaging the spacers.

As it may be hard to reach the inner tie-down brackets (C) with the cargo in place, consider fastening the tie-down studs (B) and straps to the tie-down brackets and temporarily placing the straps over the container roof (D) before loading the cargo.

 **NOTE!**
Use airline approved straps.



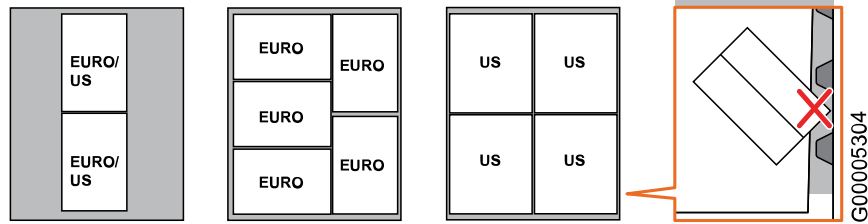

Top view

Fig. 17

4.  **CAUTION!**
Make sure that the cargo does not block the airflow between the spacers.

Load the cargo into the container. Make sure of a proper airflow around the cargo, distribute the cargo weight evenly and minimize the time the container doors are open.

5.  **CAUTION!**
Cargo that is not properly strapped may shift and obstruct the air flow, causing temperature deviations as well as cargo and container damage.

Secure the cargo to the tie-down brackets in the cargo space using airline approved straps.

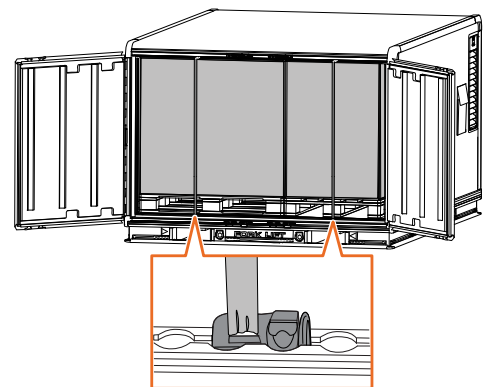



Fig. 18

G00005414

6.  **WARNING!**
Before closing the doors, make sure that nobody is inside the cargo space.

Close and lock the doors. If applicable, seal both of the doors with security seals on the locks.

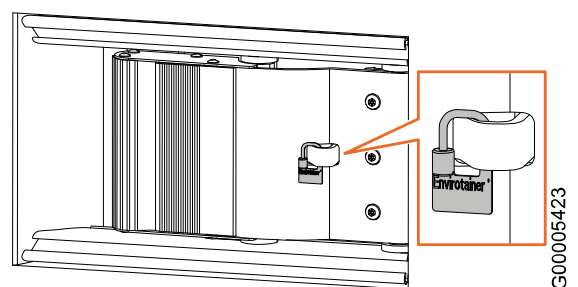

Fig. 19

G00005423



7. Place any shipping documents or checklists in the container placard holder.

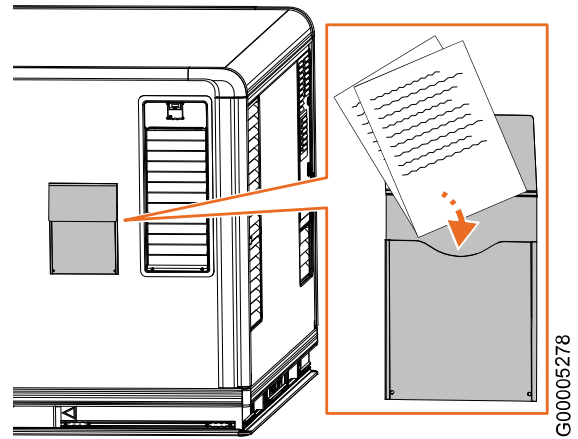

Fig. 20

8. If applicable, seal the control unit with a security seal (Ø 2-4 mm (0.08-0.16")) inserted through the slot in the latch. Refer to **3.4 Attachment points for security seals**.

Use the info button to view information. Refer to **4.4.8.10 View information on a sealed control unit**.

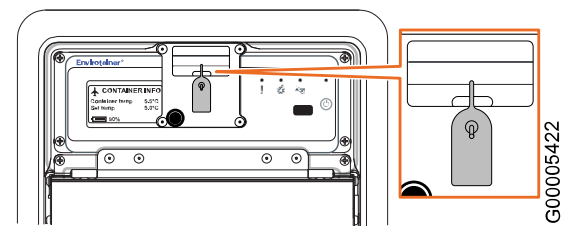

Fig. 21

9. If applicable, place a temperature data logger in the ventilated box beside the charging unit to record the ambient temperature.

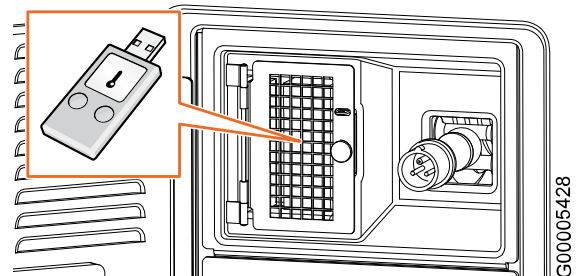

Fig. 22

4.4.5 CHARGING THE CONTAINER

4.4.5.1 SAFETY



WARNING!

Risk of electric shock. Do not charge the container outdoors or in damp and/or humid environments.



WARNING!

Risk of fire, and violation of the aircraft security. Do not charge the container inside an aircraft.



WARNING!

Risk of electric shock. Visually inspect the charging cable, and any adapters used, for any abnormalities before connecting it to a power supply. Connectors shall be inspected for residual water or other contamination. If the cable is damaged, bypass the cable winder.



WARNING!

Risk of electric shock. Do not move the container when the charging cable is connected to a power supply.



CAUTION!

Risk of container damage. Always pull out all of the charging cable, approximately 10 m (32 ft), when charging. Charging with part of the charging cable left inside the cable winder can cause damages to the cable or the cable winder.



CAUTION!

If possible, do not use any additional extension cable. If an extension cable is required, use as short a cable as possible and make sure that it is rated for 20 A / that the cross-section of the wires is at least 2.5 mm² (0.0039 inch²).



CAUTION!

The initial current peak during charging may be high, with additional strain on the power supply fuses. If the container is connected to a sensitive power grid it may cause flickering in the facility. Do not connect more than one container per single-phase to avoid overload of the power supply fuse.



CAUTION!

Do not charge in ambient temperatures below -20 °C (-4 °F) or above +40 °C (+104 °F). Charging in temperatures above +30 °C (+86 °F) may result in prolonged charging time.

4.4.5.2 CHARGING INFORMATION**Table 7 Charging information**

Parameter	Specification
Optimum ambient temperature during charging	0 to +20 °C (+32 to +68 °F)
Maximum power consumption during charging	Container switched off: 1200 W Container operating: 1850 W
Circuit capability requirements	less than 200 V power supply: 20 A 200 V or more power supply: 10 A

The charging time depends on both the battery level when the charging begins and the ambient temperature during charging. The charging capacity of the battery is reduced in ambient temperatures outside the optimum range.

For more information, including maximum charging time, refer to **6. Technical Specification**.

4.4.5.3 THE CHARGING UNIT

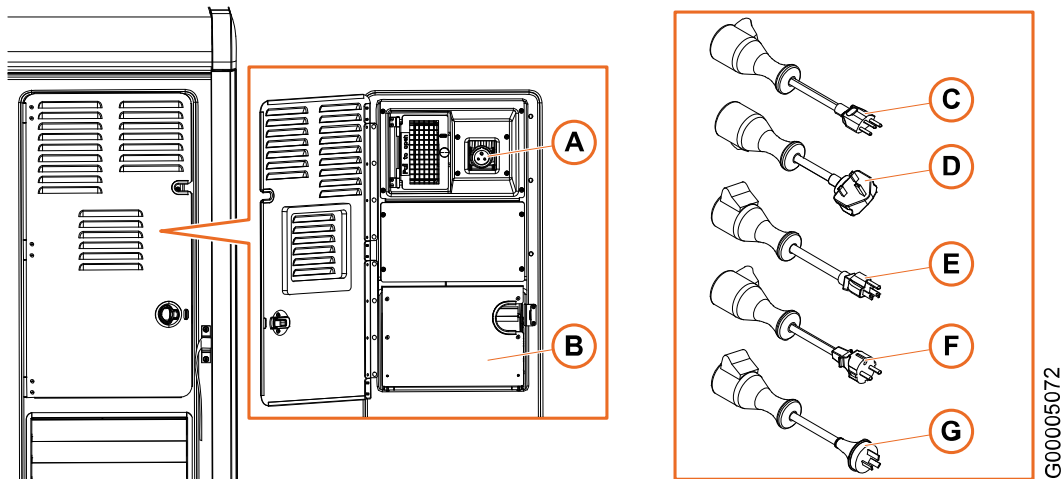

Fig. 23

The charging unit is used for charging the internal batteries of the container. It contains a charging cable (A) and an adapter case (B) with the following selection of adapters:

Table 8 Adapters included

Pos	Adapter	Specification	Part number (P/N)
C	Swiss SEV 1011	10 A, 250 V	807M
D	BS 1363	13 A, 250 V	807P
E	Nema 5–15P	15 A, 125 V	807Q
F	CEE 7/7	16 A, 250 V	807R
G	AS/NZS 4417	10 A, 250 V	807S

4.4.5.4 CHARGE THE CONTAINER

1. Open the cover of the charging unit and pull out all of the charging cable (approximately 10 m (32 ft)).

⚠ CAUTION!

Charging with part of the charging cable left inside the cable winder can cause damages to the cable winder.

⚠ CAUTION!

Tripping hazard. Avoid loops, walkways and forklift routes when routing the charging cable.

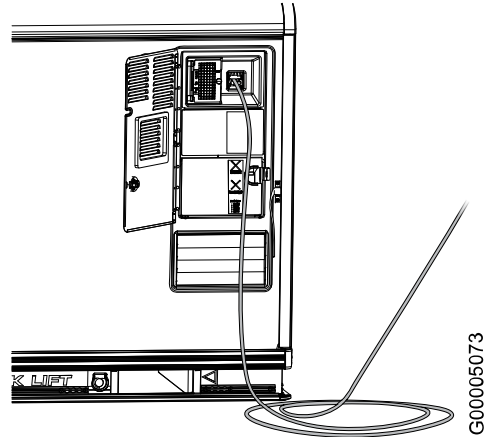

Fig. 24

2. Determine if the blue CEE industrial plug of the charging cable can be used, or if an adapter is required.

- If an adapter is required, continue from step **3**.
- If the CEE industrial plug can be used, continue from step **5**.

3. Pull out the adapter case and select the appropriate type of adapter. Additional adapters can be ordered separately from Envirotainer. Refer to **4.4.5.5 Additional charging adapters**.

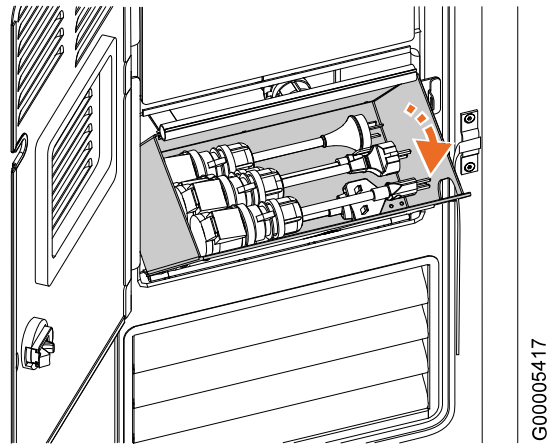

Fig. 25

4. Connect the adapter to the charging cable.

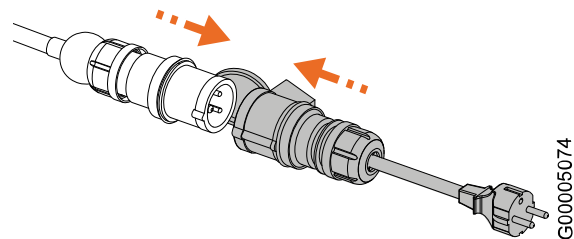

Fig. 26



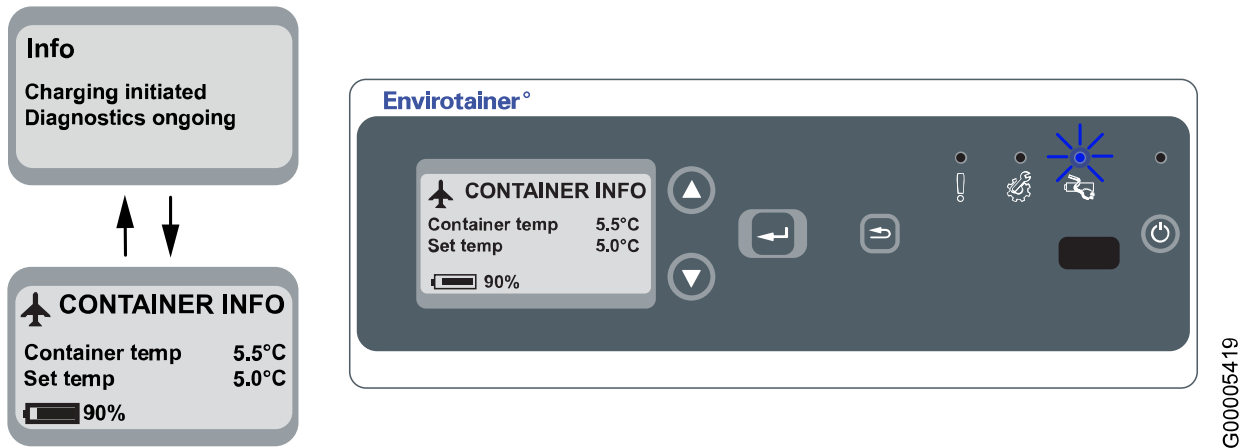

Fig. 27

5. Connect the adapter or CEE industrial plug to the power supply. The charging indicator (blue light) on the control unit starts flashing within 30 seconds, to indicate that the container is charging, and continues to flash throughout the charging.

The first hour of charging consists of a diagnose phase, during which the battery level is not updated on the display. The display switches between **CONTAINER INFO** and **Info, Charging initiated, Diagnostics ongoing** (or **Info, Pre-charging, Please wait** depending on software version).

6. When the blue charging indicator illuminates with a fixed light, the charging is completed. Disconnect the adapter or CEE industrial plug from the power supply.

NOTE!

The fixed light may occur before the battery level on the display reaches 100%, depending on the charging conditions, but the batteries are still fully charged.

7. If applicable, disconnect the adapter from the charging cable and return it to the adapter case.

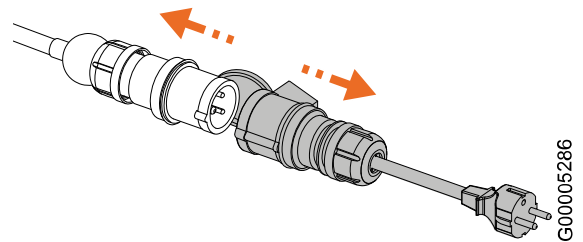

Fig. 28

8. Return the entire charging cable into the charging unit (pull the cable to make it retract) and close the cover.



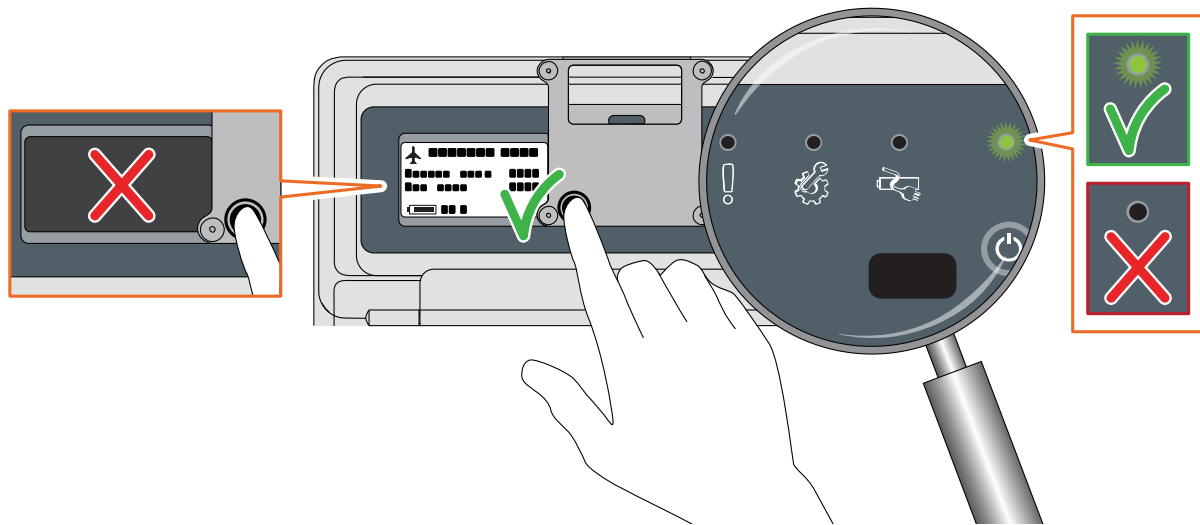

Fig. 29

9. Make sure that the control unit is powered on: the green indicator light on the control unit is lit, and the display lights up at a push of the Info button. If it does not, refer to **5. Troubleshooting**.

⚠ CAUTION!

If the control unit is not powered on when the charging cable has been disconnected from the power supply, the container cannot maintain the set temperature.

4.4.5.5 ADDITIONAL CHARGING ADAPTERS

The following additional adapters can be ordered from Envirotainer:

Table 9 Additional adapters available for order

Adapter	Specification	Part number (P/N)
NEMA 6-15R	15A, 250V	807X
NEMA L15-30P	30A, 250V	807Y

Place an order by sending an e-mail, containing the following information, to logisticspareparts@envirotainer.com:

- Part number and quantity of the desired adapter(s)
- Customer name and contact person, including contact details
- Billing address
- Delivery address, if different from the billing address
- If applicable, the name of the preferred forwarding agent, along with customer number. It is however recommended to use Envirotainer's forwarding agent.

4.4.5.6 BYPASS THE CABLE WINDER FOR CHARGING

This instruction is only applicable if the charging cable or cable winder has been damaged and can no longer be used for charging.

1. Open the cover of the charging unit and pull out the adapter case. When the adapter case reaches a stop, remove the adapters, then continue pulling the case to reach the CEE industrial plug and socket behind.

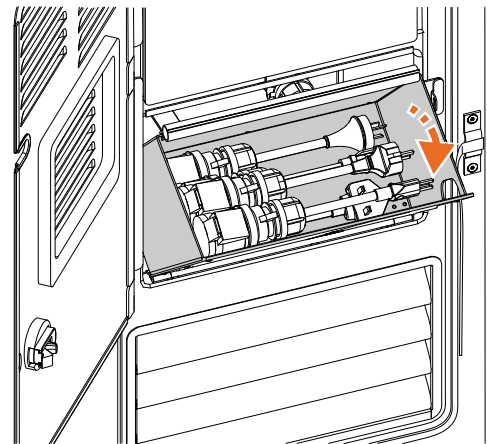
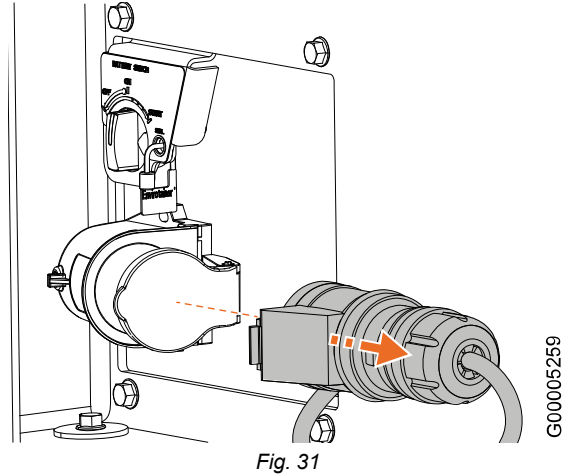

Fig. 30

G00005417



2. Disconnect the charging cable from the socket and connect the appropriate type of adapter to the socket.



3. Connect an extension cable to the adapter. The extension cable shall be as short as possible, and must be rated for 20 A / have a wire cross-section of at least 2.5 mm² (0.0039 inch²).

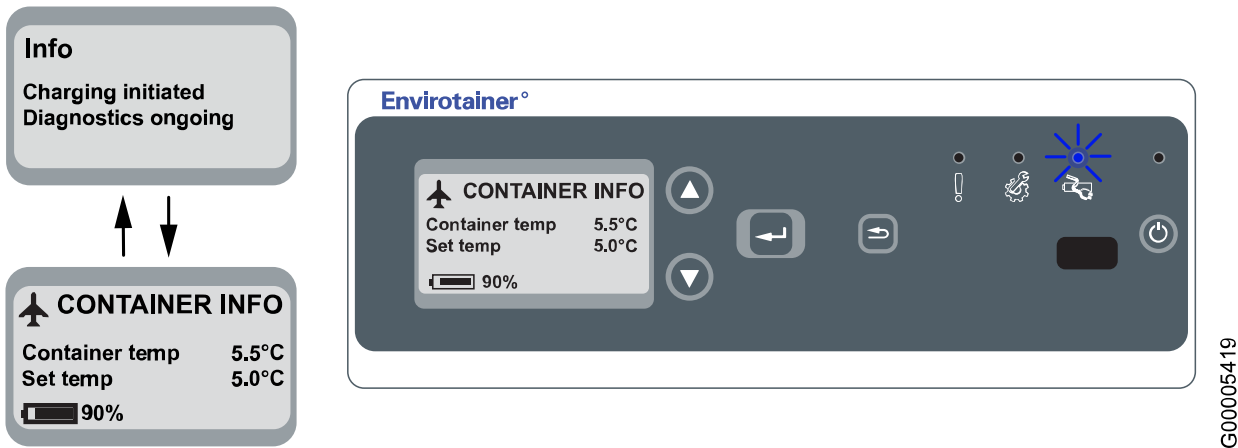

Fig. 32

4. Connect the extension cable to the power supply. The charging indicator (blue light) on the control unit starts flashing within 30 seconds, to indicate that the container is charging, and continues to flash throughout the charging.
The first hour of charging consists of a diagnose phase, during which the battery level is not updated on the display. The display switches between **CONTAINER INFO** and **Info, Charging initiated, Diagnostics ongoing** (or **Info, Pre-charging, Please wait** depending on software version).

5. When the blue charging indicator illuminates with a fixed light, the charging is completed. Disconnect the extension cable from the power supply.

NOTE!

The fixed light may occur before the battery level on the display reaches 100%, depending on the charging conditions, but the batteries are still fully charged.

6. Disconnect the adapter from the socket in the container, and connect the original charging cable to the socket.



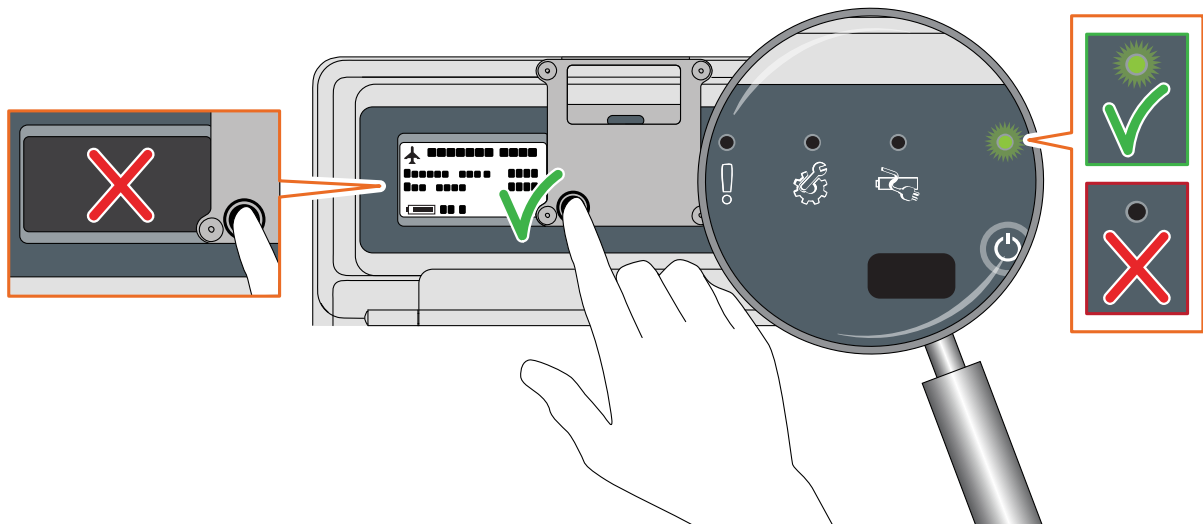

Fig. 33

G00005256

7. Make sure that the control unit is powered on: the green indicator light on the control unit is lit, and the display lights up at a push of the Info button. If it does not, refer to **5. Troubleshooting**.



CAUTION!

If the control unit is not powered on when the charging cable has been disconnected from the power supply, the container cannot maintain the set temperature.

8. Return all adapters to the adapter case, and close the adapter case.
9. Close the cover of the charging unit.

4.4.6 HANDLING THE CONTAINER DURING SHIPMENT

4.4.6.1 SHIPPING PRECAUTIONS

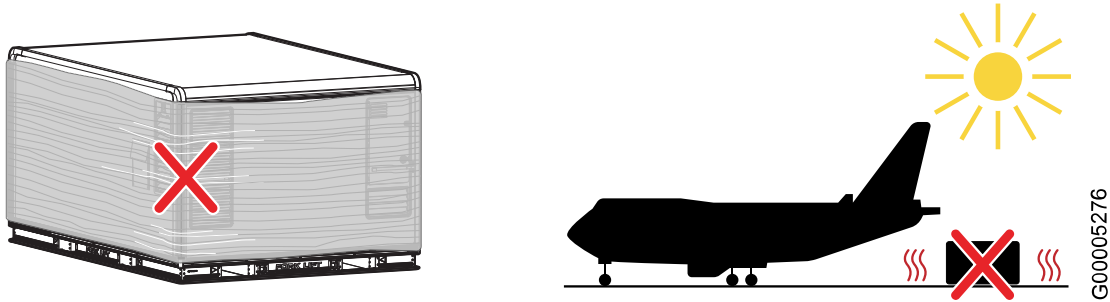

Fig. 34

! CAUTION!
Do not wrap or cover the container. If the container is wrapped or covered, the air inlets and outlets are blocked, and the container may overheat.

! CAUTION!
Limit the time on the tarmac during aircraft loading, to avoid temperature extremes and direct sunlight.

4.4.6.2 STRAP THE CONTAINER

1. If the container must be strapped during ground transport, fasten the straps to the eyelets (A) and/or the exterior tie-down brackets (B) on the container base.

! CAUTION!
Risk of container damage. Do not place any straps over the container roof.

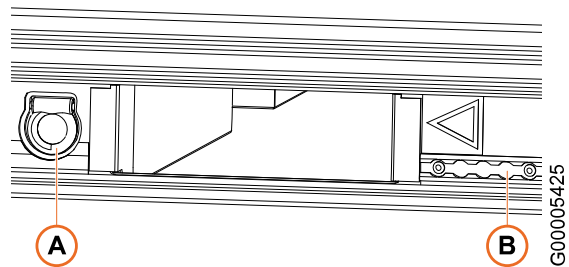

Fig. 35

4.4.7 STORING THE CONTAINER



CAUTION!

Do not store any containers, cargo or other items on top of the container.

Minimum storage requirements:

- **Placement:** On flat ground (to make sure that water will not collect in or around the container).
- **Ambient temperature:** -40 °C to +50 °C (-40 °F to +122 °F).

If possible, store the container indoors away from direct sunlight.

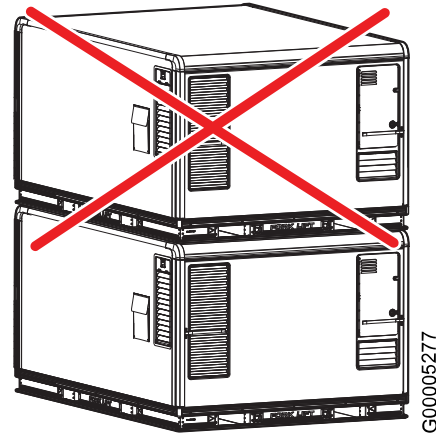

G00005277

Fig. 36

4.4.7.1 LONG-TIME STORAGE (NOT IN SHIPMENT)

During long-time storage (more than seven days), the batteries must be fully charged every 14 days due to self-discharge. Refer to [4.4.5 Charging the container](#).

4.4.8 OPERATING THE CONTROL UNIT

4.4.8.1 THE CONTROL UNIT

The control unit is the user interface for operating the container, and can be used for:

- Turning the container on/off
- Setting the container temperature
- Starting pre-conditioning
- Checking information, such as current cargo space temperature and battery level
- Viewing activated alerts and alarms
- Performing functional tests

The default mode when the display is turned on is **CONTAINER INFO**. If there are any messages, for instance alerts, alarms, or information during pre-conditioning and charging, the display toggles between default mode and the message.

In default mode, the display enters sleep mode 20 seconds after the last interaction. To wake the display from sleep mode, refer to **4.4.8.3 Wake display from sleep mode**.

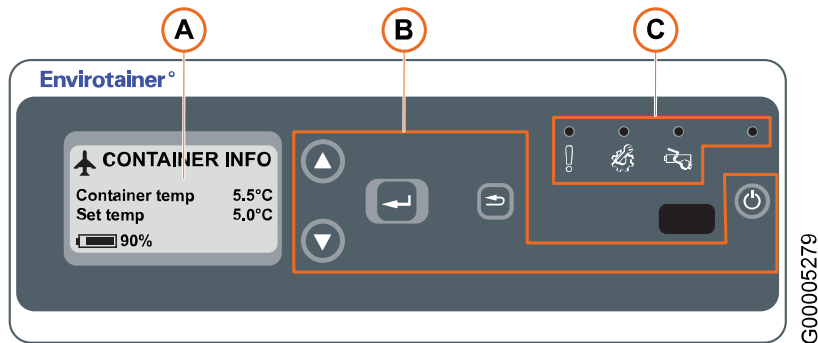

Fig. 37 Control unit features

Table 10 Control unit features

Pos	Description
A	Display, refer to Table 11
B	Buttons, refer to Table 12
C	Indicator lights, refer to Table 13

→

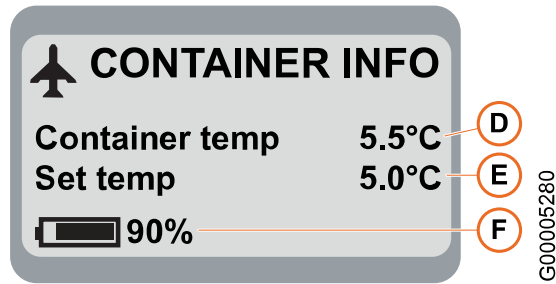

Fig. 38 Display (default mode)

Table 11 Display (default mode)

Pos	Description
D	Current temperature in the cargo space (°C or °F depending on setting)
E	Current set temperature (°C or °F depending on setting)
F	Remaining battery level in percent

Table 12 Buttons

Button	Description	Button	Description
	ON/OFF: Switch the control unit on/off		UP: Step upwards in the menu
	MENU/ENTER: <ul style="list-style-type: none"> Enter menus Confirm changes 		DOWN: Step downwards in the menu
	BACK: Return to previous menu		

Table 13 Indicator lights

Light	Description
	SYSTEM INDICATOR (green light): Steady light: The container system is powered on
	CHARGING INDICATOR (blue light): Flashing light: Charging in progress Steady light: Charging completed
	ALERT INDICATOR (yellow light): Flashing light: There is an active alert
	ALARM INDICATOR (red light): Flashing light: There is an active alarm



MENU STRUCTURE

The control unit has the following menu structure, starting from the default mode (the menu structure may vary slightly due to different software versions):

Table 14 Menu structure

TEMP MENU	SET TEMP	Set the “set temp”
	CONTAINER TEMP	Show the container temperature
	AMBIENT TEMP	Show the ambient temperature
	TEMP UNIT	Set the temperature unit (°F or °C)
SYSTEM MENU	ALARM VIEW	Show active alarms
	ALERT VIEW	Show active alerts
	SW VERSION	Only for Envirotainer use
	SYSTEM INFO	Only for Envirotainer use
	TIME & DATE	Show the time and date
	OPER. MODE	Show the operation mode
	SETUP	Only for Envirotainer use, login required
	CONN.STATUS	Show the connectivity status

4.4.8.2 SWITCH THE CONTAINER ON/OFF

Switch the container on:

1. Press . During start-up, the display shows **System On**, and the four indicator lights are lit one by one (yellow-red-blue-green) for function testing purposes.
If the indicator lights are not lit during start-up, refer to **5. Troubleshooting**.
2. Make sure that all indicator lights except the system indicator (green light) turn off after one second, and that the display is in default mode (showing **CONTAINER INFO**).
If the indicator lights do not turn off, or if there is an active alert or alarm (the display toggles between default mode and an alert or alarm text), refer to **5. Troubleshooting**.

Switch the container off:

1. Press and hold for about 3 seconds.

4.4.8.3 WAKE DISPLAY FROM SLEEP MODE

1. Press the info button (A) or, if the lid is open, .

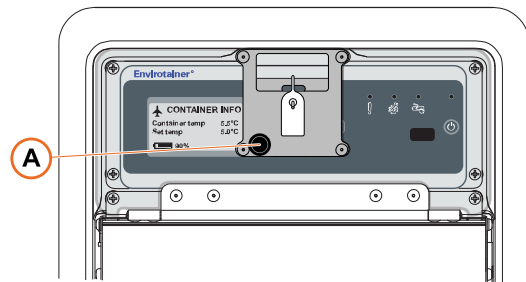











Fig. 39





G00005281

4.4.8.4 SET THE TEMPERATURE

1. If applicable, change between Celsius and Fahrenheit:
 - 1a. Press  to enter the main menu; the display shows **TEMP MENU**.
 - 1b. Press  to enter the **TEMP MENU**; the display shows **SET TEMP**.
 - 1c. Use  or  to step to **TEMP UNIT**.
 - 1d. Press  to change between Celsius (**Current unit C Set changes to F**) and Fahrenheit (**Current unit F Set changes to C**), depending on the current setting.
 - 1e. Press  until back in default mode.
2. Press  to enter the main menu; the display shows **TEMP MENU**.
3. Press  to enter the **TEMP MENU**; the display shows **SET TEMP**.
4. Press  to enter the **SET TEMP**; the display shows **SET NEW TEMP**.

 **NOTE!**







The **SET NEW TEMP** mode is activated for 30 s. If the display returns to default mode before new set temperature has been confirmed by pressing , the new container set temperature is not saved.

5. Use  and  to change the container set temperature with increments of 0.5 °C (1.8 °F). Hold down the buttons to speed up the change.
6. Press  to confirm the new container set temperature; the display shows **Setting saved**.
7. Press  until back in default mode.
8. Confirm that the container set temperature is correct.

4.4.8.5 CHECK THE OPERATION MODE

The container has three operation modes:

- **Cooling:** There are four cooling power steps, **Cool Pow 1-4**, where **Cool Pow 4** provides maximum cooling. When cooling is not required **Cool Pow 0** is displayed. Air is still circulated in the cargo space.
- **Heating:** There are two heating power steps, **Heat Pow 1-2**, where **Heat Pow 2** provides maximum heating. When heating is not required **Heat Pow 0** is displayed. Air is still circulated in the cargo space.
- **Defrosting:** There is one defrosting power step, **Defrost Pow 2**. During this power step the cooling system is shut down for a few minutes to defrost the evaporator. The defrosting process does not affect the air temperature in the cargo space.

1. Press  to enter the main menu; the display shows **TEMP MENU**.
2. Use  or  to step to **SYSTEM MENU** and press  to confirm; the display shows **ALARM VIEW**.
3. Use  or  to step to **OPER. MODE**.
4. Check the current operation mode.
5. Press  until back in default mode.

4.4.8.6 CHECK THE BATTERY LEVEL









The battery level is shown on the control unit display in default mode, see [Fig. 38](#) and [Table 11](#).

The battery level on the display is continuously updated, except for during the first hour of charging.

The maximum battery level is 100 %, which is achieved when charging starts from low battery voltage. If charging starts from a high battery voltage, the blue charge indicator may illuminate with a fixed light (indicating that charging is completed) before the battery level reaches 100 %, but the batteries are still fully charged.

For instructions on battery charging, refer to [4.4.5 Charging the container](#).

4.4.8.7 VIEW ACTIVATED ALERTS AND ALARMS

1. Press  to enter the main menu; the display shows **TEMP MENU**.
2. Use  or  to step to **SYSTEM MENU** and press  to confirm; the display shows **ALARM VIEW**.
3. View activated alarms or alerts:
 - To view alarms: Press  to confirm; the display shows activated alarms. The activated alarm is shown as **ALARM 1/1**.
Note the alarm text and refer to [5. Troubleshooting](#) for a possible solution.
 - To view alerts: Use  or  button to step to **ALERT VIEW** and press  to confirm; the display shows activated alerts. The activated alert is shown as **ALERT 1/1**.
Note the alert text and refer to [5. Troubleshooting](#) for a possible solution.
4. Press  until back in default mode.







4.4.8.8 CHECK THE CONNECTIVITY STATUS

NOTE!

Only available on containers with P/N 140010R-B-()-().

The container has six connectivity status modes:

- **Disabled:** The connectivity switch is set to disabled mode. No information will be sent from the telemetry module. Refer to [4.4.9 Connectivity switch](#).
- **Connected:** The connectivity switch is set to automatic mode and the telemetry module has reception and is sending information. Refer to [4.4.9 Connectivity switch](#).
- **Not connected:** The connectivity switch is set to automatic mode but the telemetry module has no reception because of its location at the moment and is unable to send information. Refer to [4.4.9 Connectivity switch](#).
- **No communication:** The telemetry module is unable to send information, most likely because of a power/COM cable malfunction. Contact Envirotainer. Refer to [1.4 Contact](#).
- **FDM comm error:** The telemetry module is unable to send information, most likely because of a telemetry module malfunction. Contact Envirotainer. Refer to [1.4 Contact](#).
- **Flight Sw. error:** There is a connectivity switch malfunction. Contact Envirotainer. Refer to: [1.4 Contact](#).

1. Press  to enter the main menu; the display shows **TEMP MENU**.
2. Use  or  to step to **SYSTEM MENU** and press  to confirm; the display shows **ALARM VIEW**.
3. Use  or  to step to **CONN.STATUS**.
4. Check the current status mode.
5. Press  until back in default mode.

4.4.8.9 PERFORM A FUNCTIONAL TEST

1. Disconnect the container from the power supply (if connected).
2. Switch on the container (if switched off). Refer to **4.4.8.2 Switch the container on/off**.
3. Set the temperature to 5 °C (41 °F) below the ambient temperature. Refer to **4.4.8.4 Set the temperature**.
4. Make sure that air is discharged from the air guides in the ceiling.

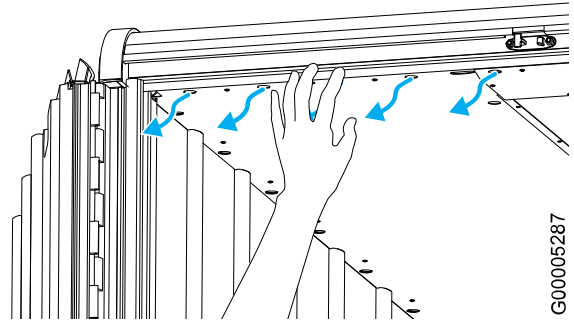

Fig. 40

G00005287

5. Make sure that the yellow alert and red alarm indicators do not flash. If the alert or alarm indicator flashes, an alert or alarm text is shown on the display. Note the alert or alarm text and refer to **5. Troubleshooting** for possible solutions.

It is also possible to view all activated alerts or alarms in the control unit menu, refer to: **4.4.8.7 View activated alerts and alarms**.

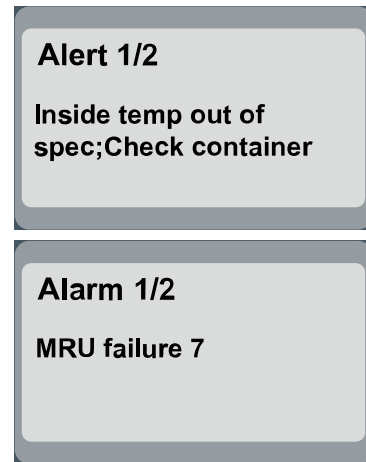

Fig. 41

G00005307

4.4.8.10 VIEW INFORMATION ON A SEALED CONTROL UNIT

When the control unit has been sealed, it is still possible to view information on the display:

1. Press the info button (A) repeatedly to toggle between default mode, alarm status and alert status. The backlight illuminates for 20 seconds when the button is pressed.

NOTE!
It is only possible to toggle through the menu with the info button — no changes to the settings can be made.

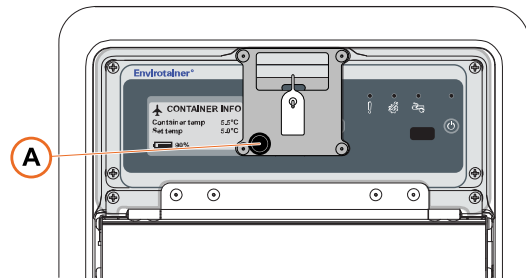

Fig. 42

G00005281

4.4.8.11 CHECK DATE OF NEXT TEMPERATURE CONTROL SYSTEM VERIFICATION

The temperature control system is verified annually. The verification is recorded with a verification sticker placed on the display unit. Next verification must be performed before the last day of the month indicated on the "due" part of the sticker.

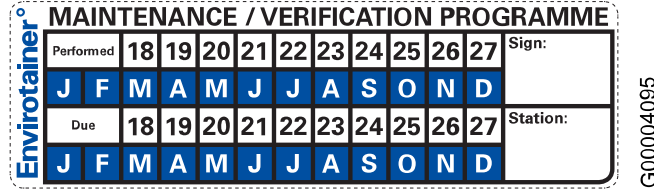

Fig. 43

If verification has not been performed as scheduled, please contact Envirotainer. Refer to **1.4 Contact**.

4.4.9 CONNECTIVITY SWITCH

NOTE!

Only available on containers with **P/N 140010R-B-()-()**.

The container is provided with connectivity equipment for wireless transmission of shipment data. It has a built in flight detection that automatically turns the connectivity off when the container comes close to an aircraft, and turns it back on again when the container is at a safe distance from the aircraft. If required, the connectivity can also be disabled manually using a connectivity switch, to enable transport on an aircraft for which the operator has not approved the use of equipment based on automatic flight detection.

Refer to: **4.4.9.1 Disable connectivity**

4.4.9.1 DISABLE CONNECTIVITY

1. Open the cover of the charging unit and pull out the adapter case. When the adapter case reaches a stop, remove the adapters, then continue pulling the case to reach the flight switch behind.

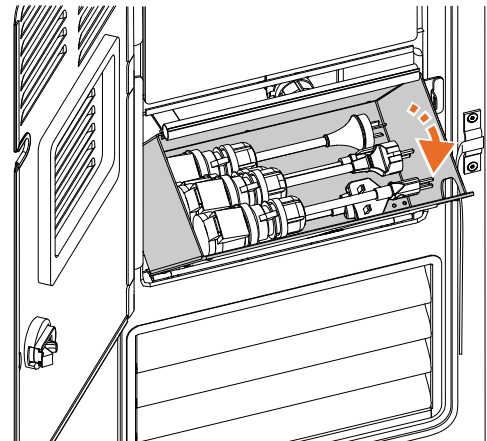

Fig. 44 Pull out the adapter case.

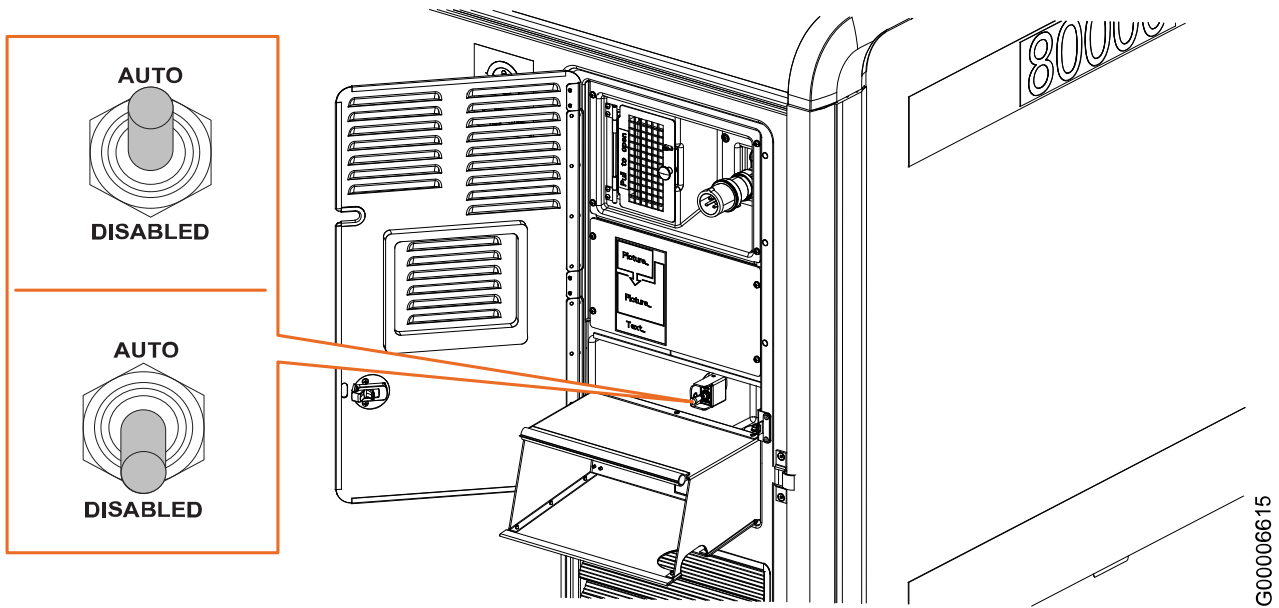

Fig. 45

2. Toggle the connectivity between automatic flight detection mode and disabled:
 - Connectivity switch towards **DISABLED**: The connectivity is disabled.
 - Connectivity switch towards **AUTO**: The connectivity is in automatic flight detection mode. If the connectivity switch is switched towards **AUTO** while the container is close to an aircraft, the connectivity will not be turned on until the container has left the aircraft.
3. Return all adapters to the adapter case, and close the adapter case.

5. TROUBLESHOOTING

These troubleshooting tables can be used when the control unit indicates an alert or alarm, or when there is a problem with the container. If a solution can not be found, contact Envirotainer for advice. In the meantime, place the cargo in a temperature-controlled area.

5.1 INFOS

An **Info** is an information message showing that the container is performing a task. The container is working properly and no action is required.

 **NOTE!**

The Info messages may differ slightly due to different software versions.

Info	Explanation or possible cause	Solution	Reference
Charging initiated Diagnostics ongoing (or Pre-charging, Please wait)	This is normal. The first hour of charging consists of a diagnose phase, during which the display switches between Container info and Info, Charging initiated, Diagnostics ongoing (or Info, Pre-charging, Please wait depending on SW version). The battery level is not updated on the display during this hour.	Wait for an hour. The info will automatically disappear when the diagnose phase is over, and the battery level will be updated on the display.	<u>4.4.5 Charging the container</u>
Preconditioning	This is normal. During preconditioning the display switches between Container info and Info, Preconditioning until the container temperature is within the tolerance of the set temperature.	Wait until the container temperature is within the tolerance of the set temperature. The info will automatically disappear when this happens.	<u>4.4.2.2 Pre-condition the container</u>

5.2 ALERTS

An **alert** means that there is an emerging risk for the shipment. A corrective action is required to mitigate this risk. Perform the applicable corrective action suggested in the solution column of the table below. The alert will automatically disappear when resolved.

Alerts are indicated by a yellow, flashing alert indicator on the control unit.

i **NOTE!**
The Alert messages may differ slightly due to different software versions.

Alert	Explanation or possible cause	Solution	Reference
Ambient temp out of spec; Check container (or just Ambient temp out of spec)	The container is exposed to extreme ambient temperatures.	Move the container to an area with ambient temperatures within the specified operation range. Monitor the container to make sure that the alert disappears.	3.8 Operating conditions
	The container has recently been exposed to extreme ambient temperatures.	Make sure that the current ambient temperature is within the specified operation range. Monitor the container to make sure that the alert disappears.	
Battery level at 30% Recommend charging (or Batteries at 30% charge level)	The battery capacity is below 30 %.	Charge the batteries.	4.4.8.6 Check the battery level 4.4.5 Charging the container
Container stopped Charging required	The batteries are depleted (the cut out voltage for the batteries has been reached) and the Mechanical Refrigerating Unit (MRU) has stopped regulating the container's inside temperature. The alert occurs when the batteries are at 0% charge level.	Charge the batteries.	4.4.5 Charging the container

→

Alert	Explanation or possible cause	Solution	Reference
Inside temp out of spec; Check container (or just Inside temp out of spec)	The cargo space air temperature deviates from the set temperature. The following alert limits apply: Container set temp <+10 °C: ±3 °C (<+50 °F: ±5.4 °F) Container set temp ≥+10 °C: ±5 °C (≥ +50 °F: ±9 °F)	See the following rows for possible cause and solution	
	The container has not been properly pre-conditioned.	Initiate or continue pre-conditioning.	<u>4.4.2.2 Pre-condition the container</u>
	The cargo has not been pre-conditioned to the container set temperature.	Check with the shipper.	
	If too warm: The container is stored at a temperature above +40 °C (+104 °F) If too cold: The container is stored at a temperature below -25 °C (-13 °F)	Move the container to an area where the temperature is -25 to +40 °C (-13 to +104 °F).	<u>3.8 Operating conditions</u>
	The container is/has been exposed to sun and/or high temperature.	Terminate exposure to sun and/or high temperature. Monitor the container to make sure that it returns to the set temperature.	
	The container doors have recently been opened, or are not properly closed.	Make sure that the doors are closed. Monitor the container to make sure that it returns to the set temperature.	
	One or more of the fans are not working.	Check for air flow from the air guides in the cargo space ceiling: <ul style="list-style-type: none"> If air flow is detected, the fans are working. Continue troubleshooting. If air flow is not detected, the fans are not working. Replace the container. 	<u>4.4.8.9 Perform a functional test</u>

→

Alert	Explanation or possible cause	Solution	Reference
<p>System too warm Charging prolonged</p>	<p>The batteries or the chargers are too warm, or there is an interruption in the battery temperature reading. Risk of receiving this alert increases if the container is charged in ambient temperatures above +30 °C (+86 °F)</p>	<p>Disconnect the container from the power supply, wait for 30 seconds, and then reconnect it to restart the charger. This resolves any interruption in the battery temperature reading.</p> <p>If the alert appears again within a few minutes, the batteries or chargers are overheated. Disconnect the container from the power supply, and preferably move it to a cooler area. Reconnect the container to the power supply (to have the charger's cooling fan running), and wait for the system to cool down. The alert will most likely reappear within a few minutes, but cooling is in progress. When the system can be assumed to have cooled down (time required depending on ambient conditions), disconnect the container from the power supply and then reconnect it to restart the charging process. If the system is still overheated, the alert will reappear. Allow the system some more time to cool down, then disconnect and reconnect the container. Repeat this until the alert does not reappear. Note that the blinking yellow alert cannot be used as an indication of the cooling status, as it remains active until the container is disconnected from the power supply and the charging is restarted.</p>	

5.3 ALARMS

An **alarm** means that the shipment is at risk, due to malfunction of one or more of the refrigeration system components. Alarms cannot be resolved without repair, and therefore requires container replacement.

Alarms are indicated by a red, flashing alarm indicator on the control unit.

Alarm	Explanation or possible cause	Solution	Reference
MRU failure 0 — MRU failure 9	One or more of the refrigeration system components are malfunctioning.	Stop the current shipment and replace the container. If the container has arrived at destination and can maintain the set temperature, ask the consignee to pick up the cargo as soon as possible.	<u>1.4 Contact</u>

5.4 HARDWARE

Problem	Possible cause	Solution	Reference
The control unit display is blank	The display is in sleep mode.	Wake the display from sleep mode.	<u>4.4.8.3 Wake display from sleep mode</u>
	The container is switched off.	Switch on the container.	<u>4.4.8.2 Switch the container on/off</u>
	The batteries are not charged.	Charge the batteries.	<u>4.4.5 Charging the container</u>
The indicator lights do not light up during startup		Replace the container.	<u>1.4 Contact</u>
The batteries do not charge	The first hour of charging consists of a diagnose phase, during which the battery level is not updated on the display.	If the problem occurs during the first hour of charging: check if the blue charging indicator is flashing: <ul style="list-style-type: none"> • If the charging indicator is flashing, wait for one hour, then monitor the battery level. • If the charging indicator is not flashing, continue troubleshooting. 	
	The container is not connected to a power supply.	Connect the container to a power supply.	<u>4.4.5 Charging the container</u>
	The fuse in the power supply central of the facility has been tripped.	Reset the fuse.	



Problem	Possible cause	Solution	Reference
The batteries do not charge (continued)	The adapter is broken.	If available, use a spare adapter.	
	The charging cable is damaged.	Visually inspect the cable. If the cable is damaged, bypass the cable winder.	<u>4.4.5.6 Bypass the cable winder for charging</u>
	The charging cable plug is not connected to the cable winder.	Connect the charging cable plug to the cable winder.	(Applicable part of) <u>4.4.5.6 Bypass the cable winder for charging</u>

6. TECHNICAL SPECIFICATION

CODE	
IATA ULD type code	RAP
ATA code	LD-9
NAS 3610 identifier	2A2C

REFRIGERATION SYSTEM	
Thermostat-controlled air conditioning system with compressor cooling and electrical heating. Powered by rechargeable batteries.	
Recharging power supply	100-240 V AC, 50-60 Hz
Maximum power consumption during charging	1850 W
Maximum charging time	12 h****
Container set temperature range	0 to +25 °C (+32 to +77 °F)
Temperature tolerance in cargo space	
at set temp ≤ +10 °C (≤ +50 °F)	± 3 °C (± 5.4 °F)
at set temp > +10 °C (> +50 °F)	± 5 °C (± 9 °F)
Autonomy at container set temperature +5 °C (+41 °F)	30 h*
Operation range at container set temperature +5 °C (+41 °F), ambient conditions**	-25 to +40 °C (-13 to +104 °F)
Storage temperature range	-40 to +50 °C (-40 to +122 °F)

DIMENSIONS	
External cube (volume)	11.5 m ³ (406.1 ft ³)
External dimensions (L x W x H)	3175 x 2235 x 1626 mm (125 x 88 x 64")
Internal dimensions (L x W x H)	2465 x 2055 x 1260 mm (97 x 80.9 x 49.6")
Door opening (W x H)	2055 x 1260 mm (80.9 x 49.6")
Internal cube (volume)	6.38 m ³ (224.2 ft ³)

WEIGHT	
Tare weight***	1,100 kg (2,425 lb)
Max gross weight	6,033 kg (13,300 lb)
Max net weight***	4,933 kg (10,875 lb)

OTHER INFORMATION	
Suitable for use on aircraft A300, A310, A330, A340, A350, A380, B747, B767, B777, B787, DC10, IL86, MD11, L1011. For other aircrafts, alternative operating procedures may apply.	
Forkliftable with a slot-height of 102 mm (4"), slot-width of 305 mm (12") and distance 813 mm (32").	

*Minimum operating time if ambient temperature is between -10 to +30 °C (+14 to +86 °F).

**For load specification, refer to test report "TR100560".

***The tare weight (and thereby the max net weight) may change due to repairs, see the manufacturer's plate for correct weight.

****Risk of prolonged charging time if charging in ambient temperatures above +30 °C (+86 °F).

6.1 DEFINITION OF DIMENSIONS

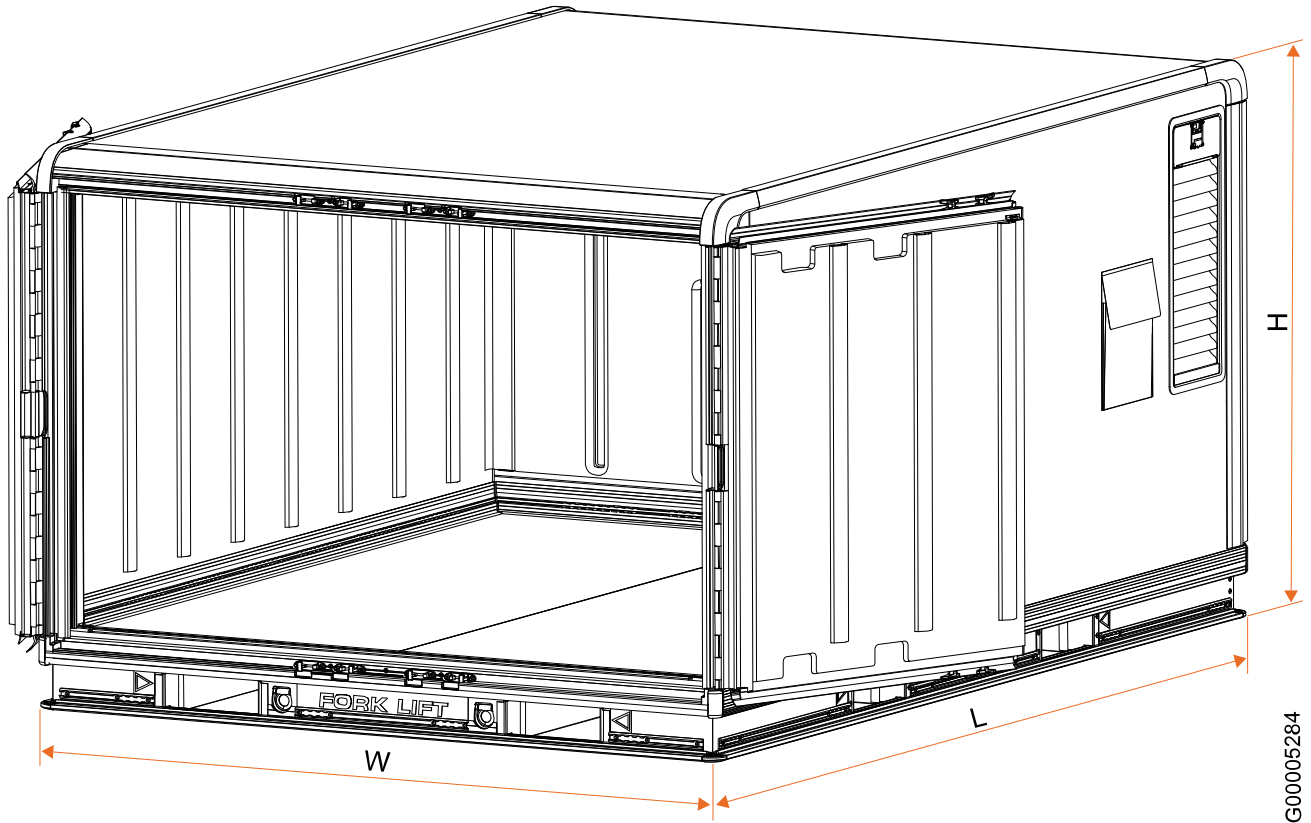

Fig. 46

Intentionally left blank

Envirotainer Engineering AB

www.envirotainer.com

Doc No:

MO-RAP-3079

Revision:

24

State

Released

Release date:

2024-02-08

Approved by

bernta